

μRack

Standard compressor racks single/two circuit

CAREL



 **μRack**

 User manual

→ **LEGGI E CONSERVA
QUESTE ISTRUZIONI** ←
**READ AND SAVE
THESE INSTRUCTIONS**

  **NO POWER
& SIGNAL
CABLES
TOGETHER**
READ CAREFULLY IN THE TEXT!

WARNINGS



CAREL bases the development of its products on decades of experience in HVAC, on the continuous investments in technological innovations to products, procedures and strict quality processes with in-circuit and functional testing on 100% of its products, and on the most innovative production technology available on the market. CAREL and its subsidiaries nonetheless cannot guarantee that all the aspects of the product and the software included with the product respond to the requirements of the final application, despite the product being developed according to start-of-the-art techniques. The customer (manufacturer, developer or installer of the final equipment) accepts all liability and risk relating to the configuration of the product in order to reach the expected results in relation to the specific final installation and/or equipment. CAREL may, based on specific agreements, acts as a consultant for the positive commissioning of the final unit/application, however in no case does it accept liability for the correct operation of the final equipment/system.

The CAREL product is a state-of-the-art product, whose operation is specified in the technical documentation supplied with the product or can be downloaded, even prior to purchase, from the website www.carel.com.

Each CAREL product, in relation to its advanced level of technology, requires setup / configuration / programming / commissioning to be able to operate in the best possible way for the specific application. The failure to complete such operations, which are required/indicated in the user manual, may cause the final product to malfunction; CAREL accepts no liability in such cases.

Only qualified personnel may install or carry out technical service on the product.

The customer must only use the product in the manner described in the documentation relating to the product.

In addition to observing any further warnings described in this manual, the following warnings must be heeded for all CAREL products:

- Prevent the electronic circuits from getting wet. Rain, humidity and all types of liquids or condensate contain corrosive minerals that may damage the electronic circuits. In any case, the product should be used or stored in environments that comply with the temperature and humidity limits specified in the manual.
- Do not install the device in particularly hot environments. Too high temperatures may reduce the life of electronic devices, damage them and deform or melt the plastic parts. In any case, the product should be used or stored in environments that comply with the temperature and humidity limits specified in the manual.
- Do not attempt to open the device in any way other than described in the manual.
- Do not drop, hit or shake the device, as the internal circuits and mechanisms may be irreparably damaged.
- Do not use corrosive chemicals, solvents or aggressive detergents to clean the device.
- Do not use the product for applications other than those specified in the technical manual.

All of the above suggestions likewise apply to the controllers, serial boards, programming keys or any other accessory in the CAREL product portfolio.

CAREL adopts a policy of continual development. Consequently, CAREL reserves the right to make changes and improvements to any product described in this document without prior warning.

The technical specifications shown in the manual may be changed without prior warning.

The liability of CAREL in relation to its products is specified in the CAREL general contract conditions, available on the website www.carel.com and/or by specific agreements with customers; specifically, to the extent where allowed by applicable legislation, in no case will CAREL, its employees or subsidiaries be liable for any lost earnings or sales, losses of data and information, costs of replacement goods or services, damage to things or people, downtime or any direct, indirect, incidental, actual, punitive, exemplary, special or consequential damage of any kind whatsoever, whether contractual, extra-contractual or due to negligence, or any other liabilities deriving from the installation, use or impossibility to use the product, even if CAREL or its subsidiaries are warned of the possibility of such damage.

DISPOSAL

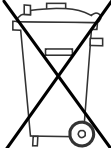

INFORMATION FOR USERS ON THE CORRECT HANDLING OF WASTE ELECTRICAL AND ELECTRONIC EQUIPMENT (WEEE)

In reference to European Union directive 2002/96/EC issued on 27 January 2003 and the related national legislation, please note that:

1. WEEE cannot be disposed of as municipal waste and such waste must be collected and disposed of separately;
2. The public or private waste collection systems defined by local legislation must be used. In addition, the equipment can be returned to the distributor at the end of its working life when buying new equipment.
3. The equipment may contain hazardous substances: the improper use or incorrect disposal of such may have negative effects on human health and on the environment;
4. The symbol (crossed-out wheeled bin) shown on the product or on the packaging and on the instruction sheet indicates that the equipment has been introduced onto the market after 13 August 2005 and that it must be disposed of separately;
5. In the event of illegal disposal of electrical and electronic waste, the penalties are specified by local waste disposal legislation.

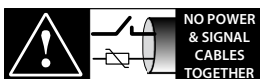

READ CAREFULLY IN THE TEXT!

WARNING: separate as much as possible the probe and digital input signal cables from the cables carrying inductive loads and power cables to avoid possible electromagnetic disturbance. Never run power cables (including the electrical panel wiring) and signal cables in the same conduits

CONTENTS

1	PRODUCT	7
1.1	General functions	7
1.2	Main characteristics	7
2	USER INTERFACE	8
2.1	Buttons - LEDs - Icons	8
2.2	LED display and Icons	9
3	STARTING THE UNIT	10
3.1	Starting for the first time	10
3.2	Unit configuration	10
3.3	Meaning of the inputs / outputs	10
4	COMPRESSOR MANAGEMENT	13
4.1	General settings	13
4.2	Compressor rotation	13
4.3	Compressor control	13
4.4	Number of compressors started with probe 1 fault	14
4.5	Compressors with different capacities	15
4.6	Manually enable/disable the compressors	15
4.7	Special MT-LT units	16
4.8	Compressor time settings	16
5	FAN AND INVERTER MANAGEMENT	18
5.1	Fan management	18
5.2	Dead band control	18
5.3	Inverter management	19
5.4	PWM-PPM management	21
5.5	Floating condenser control	21
6	VARIOUS SETTINGS	22
6.1	Manual device operation	22
6.2	Compressor hour counter and maintenance alarm	22
6.3	Set point variation from digital input	22
6.4	Type of refrigerant	22
6.5	Auxiliary probe management	22
6.6	Prevent high discharge pressure	23
7	ALARM MANAGEMENT	24
7.1	Alarms with automatic reset	24
7.2	Alarms with manual reset	24
7.3	Semiautomatic alarms	24
7.4	Alarm relay	24
7.5	Alarms from analogue inputs: temperature probe and pressure transducer:	25
8	THE SUPERVISOR NETWORK	26
8.1	Serial boards	26
8.2	Communication protocols	26
9	USER INTERFACE	26
10	LIST OF PARAMETERS	27
11	ON/OFF FAN CONTROL BOARD (CODE CONVONOFF0)	32
12	PWM TO 0 TO 10 VDC (OR 4 TO 20 MA) CONVERSION BOARD FOR FANS (CODE CONV0/10A0)	33
13	PROGRAMMING KEY (CODE PSOPZKEYA0)	33
14	SUPERVISOR MANAGEMENT	33
15	DEFAULT CONFIGURATIONS	36
16	GLOSSARY	37
17	TECHNICAL SPECIFICATION	37
18	PRODUCT CODES LIST	38
19	APPENDIX: COMPRESSOR RACK CONTROLLER, EXAMPLES OF APPLICATION DIAGRAMS	39
20	APPENDIX: CHANGES INTRODUCED IN FW RELEASE 2.0 FOR MRK0000XX0	41
21	APPENDIX: CHANGES INTRODUCED IN FW RELEASE 2.1	42
22	APPENDIX: CHANGES INTRODUCED IN FW RELEASE 2.2	42
23	APPENDIX: CHANGES INTRODUCED IN FW RELEASE 2.3	42

1 Product

1.1 General functions

1. Read pressure transducers, display data in BAR/°C (depending on the type of refrigerant gas)
2. Management of compressors with the same and different capacities
3. Management of compressor racks with two circuits, MT and LT
4. Setting of the number of compressors – fans on the unit
5. Rotation of the compressors (FIFO and by time). FIFO rotation of the fans.
6. Fan speed control (PWM OUTPUT)
7. Compressor and fan dead band management
8. Possibility to enter the compressor set point in BAR and display the value in °C by pressing the “UP” and “DOWN” buttons together when displaying the parameter values.
9. Possibility to enter the fan set point in BAR or degrees centigrade, depending on the control probe used (pressure or NTC).
10. Multifunction input: general HP alarm, ON/OFF, change SET POINT,...
11. Set point variation from digital input
12. Possibility to set the compressor-fan thermal overload/generic alarm as automatic/manual
13. Enable compressors from the “Maintenance” screen
14. Proportional plus integral function for the fan inverter.
15. Floating condenser set point
16. Optional temperature probes, with high temperature alarm threshold:
 - a- Outside air
 - b- Ambient air
 - c- Compressor discharge temperature
 - d- Suction temperature

1.2 Main characteristics

Main functions

- Control of compressor suction pressure
- Control of condensing pressure (compressor discharge)
- Complete management of the outputs available;
- Complete alarm management;
- Connection to serial line for supervision / telemaintenance;

Devices controlled

Compressors (up to 4 hermetic compressors, no part up to 2 hermetic-load capacity-controlled compressors)

- Condenser fans (max 4)
- PWM speed control

Programming

- Display and control of the values measured, on LED display
- Three levels of parameter protection: SEL (USER), PRG (INSTALLER), SEL+PRG (MANUFACTURER)
- Possibility to configure all the unit parameters using a hardware key.
- Possibility to configure the main unit parameters via serial line.
- Possibility to modify the access level to the parameters from the keypad (only from MANUFACTURER level).

Hardware

- The product comes ready for panel installation, 32x74, and DIN rail mounting.

2 User interface

The product uses a 3 digit LED display with minus sign and decimal point to display the monitored values, and ICONS for the status of the devices and operating modes. As well as displaying the values measured and the operating conditions of the unit, the user terminal (display and keypad) can be used to modify the unit operating parameters. The following figures show the μRack for panel installation and for DIN rail mounting.



Fig. 2.a









2.1 Buttons - LEDs - Icons

Button	Description
Prg mute	a) Press the button, when switching the instrument on, until the string "DEF" is shown on the display, to load the default values. b) Press the button for more than 5 sec, to set the password for accessing the INSTALLER parameters. c) Press the button for more than 3 sec, when the list of parameters is displayed, to accept the modifications and return to the main display (control pressure/temperature) d) Press the button for more than 3 sec when the list of parameter groups is displayed, "-/","-C","-r","-A","-M-", to return to the main display (control pressure/temperature)
▲ bar °C	a) Press the button for more than 5 sec to select between the display of the values in "BAR" or "°C". b) Press the button when the list of parameters is displayed to move to the next parameter. c) Press the button when the numeric value of a parameter is displayed to increase the value. d) Press the button when a digital value is displayed (YES-NO) to change the setting.
Sel	a) Press the button for more than 5 sec to set the password for accessing the USER parameters. b) Press the button when the list of parameters is displayed to show the numeric value of the parameter. c) Press the button when the numeric value of a parameter is displayed to accept the numeric value and return to the list of parameters.
HP LP ▼	a) Press the button to display the other controlled values. The "label" of the probe will be displayed, and then the numeric value. Example: Unit "A" single circuit -standard LP1 -the arrows scroll to HP-B2 -B3 Unit "B" two circuit -standard LP1 -the arrows scroll to LP2-HP-B3 b) Press the button for more than 5 sec to select the probe displayed permanently as the main probe. c) Press the button when the list of parameters is displayed to move to the previous parameter d) Press the button when the numeric value of a parameter is displayed to decrease the value. e) Press the button when a digital value is displayed (YES-NO) to change the setting
Prg + Sel mute	Press the two buttons together for 5 seconds to set the PWD for accessing the MANUFACTURER parameters and thus configuring the controller.
HP ▲ LP + bar ▼ °C	Press the two buttons together, when the numeric value of one of the following parameters is displayed: <ol style="list-style-type: none"> 1. comp/fan set point 2. high/low threshold to switch the display of the same parameter from BAR to °C.

Tab. 2.a

2.2 LED display and icons

The display shows the control value, temperature or pressure. depending on the selection made from the keypad.
In the event of alarms, the display shows the monitored and the alarm information in sequence.

ICONS	Description
	On when the unit of measure selected is BAR
	On when the unit of measure selected is °C
	On when there is an ACTIVE ALARM
	1) On when the MANUFACTURER parameters are being configured 2) If flashing with the ALARM icon indicates the compressor maintenance hours have been exceeded.
	1) On when the value read by the suction probe is displayed 2) If flashing with the ALARM icon indicates the activation of suction probe alarms: High Temp. Low Temp. Probe not connected
	1) On when the value read by the discharge probe is displayed 2) If flashing with the ALARM icon indicates the activation of discharge probe alarms: High Temp. Probe not connected
	1) On when the fan parameters are being configured. 2) On when at least one fan is operating 3) If flashing with the ALARM icon indicates the activation of fan alarms
	1) On when the compressor parameters are being configured. 2) On if at least one compressor step is active 3) If flashing with the ALARM icon indicates the activation of the compressor alarms
1 2 3 4	1) Indicates the state of the compressors and capacity control on 2) If flashing indicates the ON/OFF call for a new compressor step, while the device is awaiting the expiry of the delay times. 3) If the controller is used for fan control only ("01"=0) then the icon shows the status of the fans.

Tab. 2.b

3 Starting the unit

3.1 Starting for the first time

After having checked the connections, power-up the unit.

When started for the first time, the controller performs a LAMP TEST and uses the default values selected by CAREL for all the configuration parameters:

Unit with 2 compressors + 2 fans + alarm relay.

3.2 Unit configuration

The unit can be set as single or two circuit, the number of compressors for one or two circuits using parameter /01; the number of fans can then be set using parameter /09. The maximum number of devices, compressors + fans, is 5 (maximum number of relays).

First the compressors + **capacity control** and then the fans will be allocated, in sequence.

Relay no. 5 may be:

- an alarm
- a fan

The selection is made automatically according to the number of devices (fans and compressors) selected.

If 4 devices are selected (e.g.: 2 compressors (**not capacity-controlled**) + 2 fans) relay 5 can be used as an alarm relay (default setting), while if 5 devices are controlled (e.g.: 2 compressors (**not capacity-controlled**) + 3 fans), output no. 5 is automatically used to control a fan. In addition, the use of speed control, by phase control or inverter, can be set for the fans, managed using the PWM signal.

3.2.1 Input configuration

Inputs from 1 to 4 are alarm inputs for the compressors and fans configured. If 5 devices are controlled by the unit, input no. 5 is automatically an alarm input (fan alarm only). The user can decide whether the alarm inputs are normally closed (the alarm condition exists when the contact is open) or normally open (the alarm condition exists when the contact is closed) by setting parameter /14.

If 4 devices, or less, are connected to the controller, input 5 automatically becomes a multifunction input.

Parameter /15 can be used to configure the multifunction input:

- 0: no function
- 1: unit ON-OFF (ON contact NC)
- 2: change set point (set1- set2)
- 3: general high pressure switch NC
- 4: general high pressure switch 1 NO
- 5: general low pressure switch circuit 1 NC
- 6: general low pressure switch circuit 1 NO
- 7: general low pressure switch circuit 2 NC
- 8: general low pressure switch circuit 2NA
- 9: liquid level alarm NC
- 10: liquid level alarm NO
- 11: fan thermal overload/generic NC
- 12: fan thermal overload/generic NO

3.2.2 Unit ON/OFF

The controller is normally configured as always ON.

The unit can be switched on and off by:

1. Alarm (parameter **A22** can be used to select whether or not a broken probe alarm should switch the unit off).
2. Supervisor (parameter **/38** can be used to enable unit shutdown from the supervisor).
3. Digital input (parameter **/15** can be used to configure the multifunction input as ON/OFF).
4. Parameter (parameter **/39** can be used to switch the unit on or off)

Shutting down the unit, as shown on the display by the message "OFF":

- switches the controller off;
- stops the management of the various devices and the related alarms.

3.3 Meaning of the inputs / outputs

3.3.1 Table of analogue inputs

The tables below describe the type of the probes that can be connected to the inputs and their characteristics.

Analogue inputs

Input	Description	Type of probes that can be connected
B1	Ratiometric discharge pressure probe	RATIOMETRIC pressure probe (0 to 5 Volt) or NTC if /16
B2	Room temperature probe (display) / auxiliary probe	CAREL NTC temperature probe (-50T100°C; R/T 10 k at 25°C)
B3	Outside air temperature probe (floating condenser control) / auxiliary probe	CAREL NTC temperature probe (-50T100°C; R/T 10 k at 25°C)
B4	Ratiometric suction pressure probe / probe in 2nd circuit	RATIOMETRIC pressure probe (0 to 5 Volt)

Tab. 3.a

Digital inputs

Input	Description	Type of device connected
ID1	Compressor 1 / fan alarm	Generic compressor/fan alarm. Voltage-free contact.
ID2	Compressor 2 / fan alarm	Generic compressor / fan alarm. Voltage-free contact.
ID3	Compressor 3 / fan alarm	Generic compressor / fan alarm. Voltage-free contact.
ID4	Compressor 4 / fan alarm	Generic compressor / fan alarm. Voltage-free contact.
ID5	Fan alarm / Multifunction input	Generic alarm: - compressor/fan. - from general high/low pressure switch. - fan thermal overload. - liquid level. Unit On-Off. Voltage-free contact.

Tab. 3.b

Digital outputs

Input	Description	Type of device connected
No1-C1	Compressor 1 / fan	Power contactor for starting the compressor / fan
No2-C2	Compressor 2 / capacity-control / fan	Power contactor for starting the compressor / Power contactor for capacity control activation / fan
No3-C3	Compressor 3 / capacity-control / fan	Power contactor for starting the compressor / Power contactor for capacity control activation / fan
No4-C4	Compressor 4 / capacity-control / fan	Power contactor for starting the compressor / Power contactor for capacity control activation / fan
No5-C5	Alarm / fan	Power contactor for starting the fan / voltage-free contact for signalling unit alarm

Tab. 3.c

Analogue outputs

Outputs	Description
Y1	Fans speed controller (PWM)

Tab. 3.d

3.3.2 Wiring diagrams:
Panel installation:

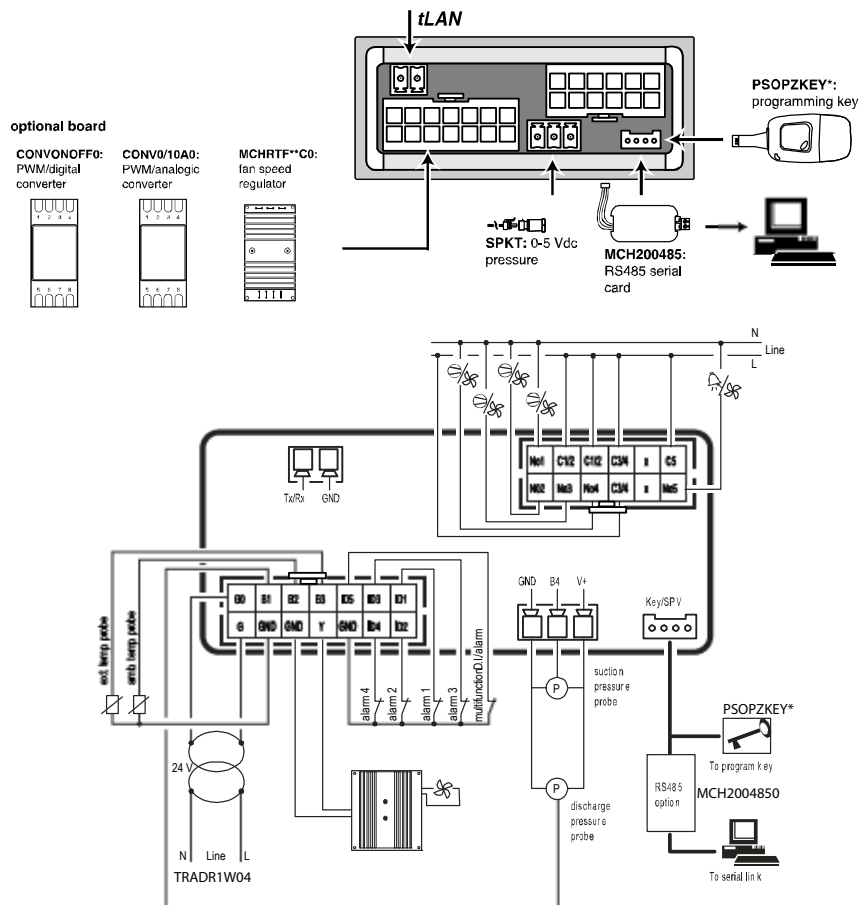

Fig. 3.a

DIN rail installation:

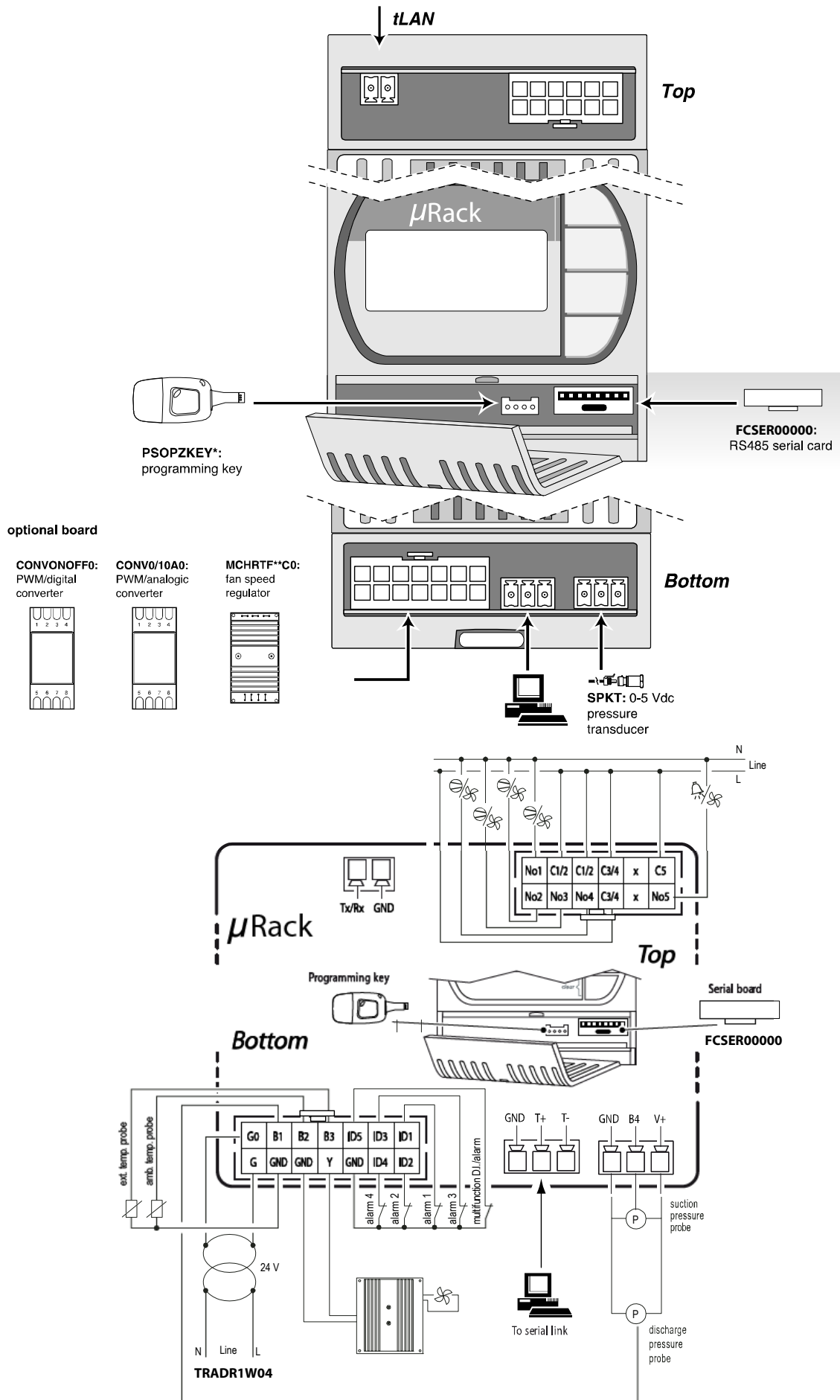

Fig. 3.b

4 Compressor management

Inputs used:

- Suction pressure probe/probes
- Digital inputs dedicated to the compressor safety devices
- Multifunction input for generic alarm (general suction pressure switch 1 and 2)

Outputs used:

- Compressor outputs **and capacity control**

4.1 General settings

Parameters used for ON/OFF control:

- number of compressors (**capacity-controlled and not**)
- compressor times
- type of control

The compressors are managed by the controller based on a pressure set point (parameter r01) and differential (parameter r02), measured by the suction probe. In the case of two circuits, the set point and the differential also need to be set for the second circuit (parameters r03 and r04).

4.2 Compressor rotation

Rotation (parameter r05) of the compressor calls ensures that the number of operating hours and the number of starts of the different compressors balance out. Rotation automatically excludes any compressors with alarm or that are disabled.

If the compressor is off for alarm or disabled, is excluded from regulation and rotation; the activation/deactivation thresholds are re-calculated based from actual number of compressors available.

In the default configuration, FIFO rotation has been selected.

Three different types of rotation can be set: **for the capacity control, only** devices rotation type available is LIFO (**no depending by r05**) parameter:

LIFO rotation (no rotation)

The first compressor to start will be the last to stop, **first capacity control activated will be the last deactivated**:

- Start: C1,C2,C3,C4.
- Stop: C4,C3,C2,C1.

FIFO rotation

The first compressor to start will be the first to stop.

- Start: C1,C2,C3,C4
- Stop: C1,C2,C3,C4.

This selection enables the rotation of the compressors so as to even out as much as possible the number of compressor operating hours.

Rotation by time

The compressor that starts will be the one with the lowest number of operating hours. When stopping the exact opposite is true, that is, the compressor with the highest number of operating hours will stop.

4.3 Compressor control

In the default configuration, "dead band" control is activated (parameter r06).

Proportional band

Proportional band control calculates, based on various parameters (SP, DF and the number of devices set) the points where the devices must switch on and off, inside the differential band. Parameters r01 (set point) r02 (differential).

Figure 4.1 shows the activation points for a system with 4 steps.

Setting the parameters listed above, each individual step will have a differential as follows:

- SP + 1 *DF/ (No. of steps) for the first;
- SP + 2 *DF/ (No. of steps) for the second;
- ...
- SP + DF for the last.

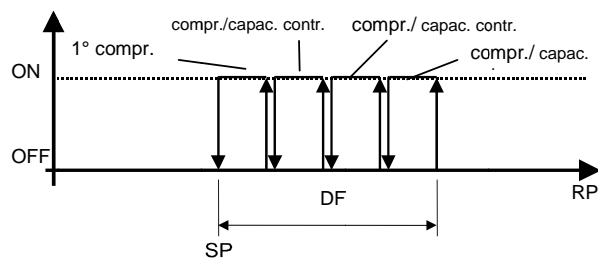

Fig 4.a

Key:

- SP Compressor set point (r01)
- DF Compressor differential (r02)
- RP Pressure read

Dead band

This type of control features the definition of a dead band to the side of the set point, within which no device is started or stopped. The devices are activated when the measured value exceeds the limit to the right (measured value greater than $SP + DZN$, see Figure 4.3). The number of devices to be activated varies according to the time elapsed outside of the dead band. The first device will start immediately, while the others will wait the set time between starts (r07). Similarly, the devices are stopped when the measured value falls below the dead band (measured value less than the set point), and remains there for a period equal to the time between device stop requests. In this case too, the first device stops immediately, while the others wait the delay time between stops (r09).

Also see the paragraph on **Time settings**.

The program will switch the devices on according to the start-up logic configured and the availability of the devices

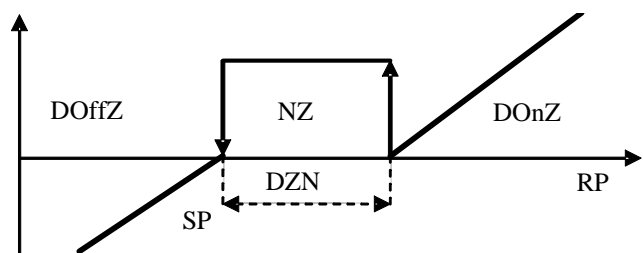

Fig. 4.b

Key:

DOffZ	Device deactivation zone
DOnZ	Device activation zone
NZ	Dead band
DZN	Dead band differential
RP	Suction pressure read
SP	Set point

Compressor dead band with variable times

The user can decide to set a variable time between calls, depending on whether the pressure is moving away from the dead band. In particular, the activation / deactivation time of the outputs decreases as the distance from the dead band increases. To set this function, the following parameters must be configured:

- Maximum compressor on time/ **capacity control** (parameter r08)
- Minimum compressor on time/ **capacity control** (parameter r07)
- Pressure differential within which the time varies. (parameter r11)
- Maximum compressor off time/ **capacity control** (parameter r10)
- Minimum compressor off time/ **capacity control** (parameter r09)

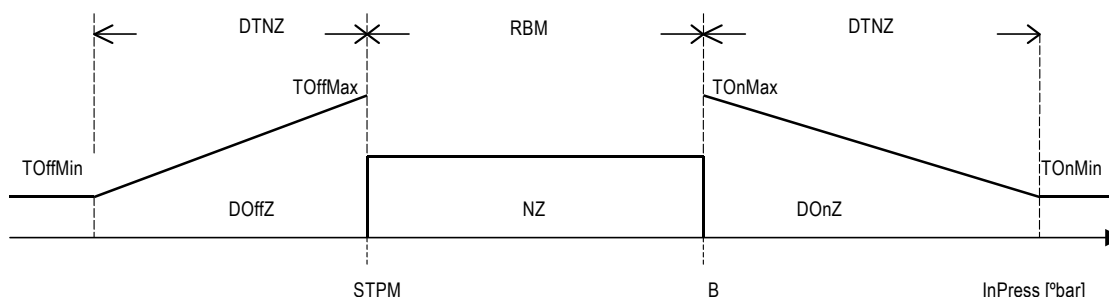

Fig. 4.c

Key:

InPress	Suction pressure	DTNZ	Differential within which the time varies
STPM	Control set point	TOnMax	Maximum compressor on time
RBM	Control band	TOnMin	Minimum compressor on time
NZ	Dead band	ToffMax	Maximum compressor off time
DOnZ	Device activation zone	ToffMin	Minimum compressor off time
DOffZ	Device deactivation zone		

In the activation phase, the following cases are possible:

1. Pressure equal to point b
same call time as the "maximum compressor on time"
2. Pressure between point b and point b + DTNZ
type of call between "Max on time" and "Min on time"
3. Pressure greater than or equal to point b + DTNZ
same call time as "Min on time"

In the deactivation phase, on the other hand, the following cases are possible:

1. Pressure equal to point STPM
same call time as the "maximum compressor off time"
2. Pressure between point STPM and point STPM - DTNZ
type of call between "Max off time" and "Min off time"
3. Pressure greater than or equal to point STPM - DTNZ
same call time as "Min off time"

N.B. To make the device call time constant in the activation phase, simply set the times TOnMax and TonMin to the same value. The same is true for the deactivation phase.

4.4 Number of compressors started with probe 1 fault

In the event of a suction probe fault or not connected alarm, parameter /07 indicates the number of **outputs (compressors and capacity control, configured with capacity-controlled compressors)**, forced on, so as to ensure minimum cooling/operation of the installation.

For two circuits, the parameter relating to the second circuit /08 must also be set. This will be related to the probe in the 2nd circuit.

4.5 Compressors with different capacities

Parameter /02 is used to choose the option of compressors with different capacities.

This allows more load steps and therefore finer control.

Once the capacity of the individual compressors has been defined (parameters /03, /04, /05, /06), the software, based on the requirements of the installation and the compressors available (without alarms or timers), will calculate the most suitable combination to satisfy the requirement. Whenever the requirement changes, the software recalculates the most suitable combination. The combination will always be greater than or equal to the requirement.

If two compressors have the same capacity, the compressor with the lower index will always be the first to start.

4.5.1 Proportional band control with different capacity compressors

Based on the pressure, the set point and the differential, the software will proportionally calculate the capacity required to bring the pressure back near the set point. At the set point plus differential the requirement will be at the maximum value, while it will be null for pressure values around or less than the set point.

$$Capacity_required = \frac{Max_Capacity \times (Setpoint - press)}{Differential}$$

4.5.2 Dead band control with different capacity compressors

The software will calculate the maximum number of combinations possible with the compressors available.

At certain intervals of time (see the paragraph on Compressor dead band with variable times), the software will call a sequence with a higher capacity.

In the deactivation phase, the opposite will occur, while in the dead band no compressors will be started or stopped.

An increase in the requirement will correspond to a different combination.

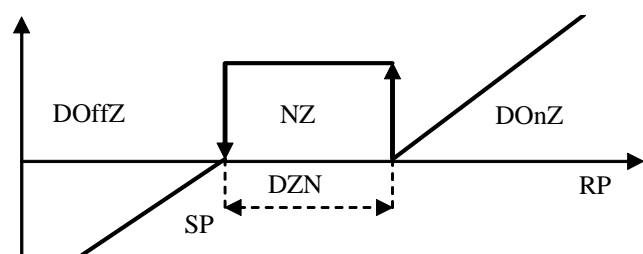

Fig 4.d

- Key:
- DOffZ Device deactivation zone
 - DOnZ Device activation zone
 - NZ Dead band
 - DZN Dead band differential
 - RP Suction pressure read
 - SP Set point: compressors (S2); fans (S1)

4.5.3 Example of compressors with different capacities

The following example looks at an installation featuring 3 compressors with different capacities, using proportional band control. As can be seen, there are 8 possible combinations available.

Set point	1.0	bar	"r01"
Differential	2.0	bar	"r02"
Comp1	5	kW	"/03"
Comp2	7	kW	"/04"
Comp3	15	kW	"/05"
Maximum capacity	27	kW	"/06"

Pressure	Requirement kW	Comp1	Comp2	Comp3	Total active capacity kW
1.1	1.35	X			5
1.6	8.1	X	X		12
1.8	10.8	X	X		12
2	13.5			X	15
2.1	14.85			X	15
2.4	18.9	X		X	20
2.5	20.25		X	X	22
3	27	X	X	X	27

Tab 4.a

4.6 Manually enable/disable the compressors

A compressor can be temporarily disabled from the control sequence. This function is very useful when needing to perform maintenance on an individual compressor. The corresponding alarms are still managed.

The following parameters are used: M01,M02,M03,M04 to enable the manual operation of the compressors. The real manual function is managed using parameters: M05,M06,M07,M08.

On unit models with capacity control (/01=9,10,...14) the compressors cannot be manually enabled/disabled directly. To exploit parameters M01,...,M08, the unit model needs to be changed (/01=1 for configurations 9, 10 and 11; /01=3 for configurations 12 and 13; /01=4 for configuration 14).

4.7 Special MT-LT units

4.7.1 Management of compressor racks with LT and MT circuits and condenser only.

The hardware features of the μRack controller can be adapted for the control of a special type of compressor rack that is becoming more widely used in small and medium installations, having the advantage of being compact and offering low cost solutions. These are compressor racks with only the condensing section, and with fan speed managed by the speed controller or external pressure switches, and separate management of the compressors in the MT and LT units. Below is an example diagram:

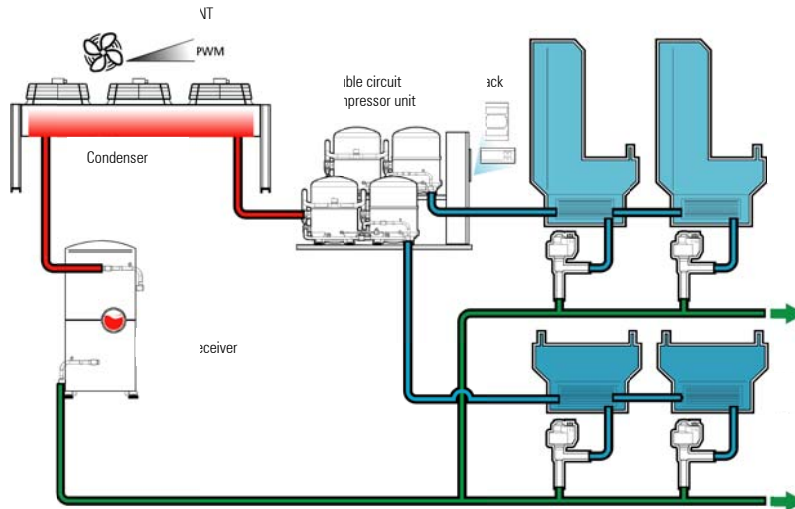

Fig 4.e

This type of system can be controlled by μRack in the following conditions:

1. the compressors must have the SAME CAPACITY
2. the max number of compressors in the MT unit and LT unit is 4. There can therefore be combinations of 2+2, 3+1, 1+1. One compressor rack will be allocated to probe LP1, and the other compressor rack to probe LP2.

4.7.2 Probes and values controlled

Function	Input	Code on display	Type of unit: A- Single circuit compressor rack B- Compressor racks with 2 circuits MT-BT
Low pressure circuit 1	B4 (pressure)	LP1	A - B
Low pressure circuit 2	B1 (pressure)	LP2	B
High pressure circuit discharge	B1 (pressure) B2 (temperature)	HP	A (press - temp) B (only temp)
Temperature 1	B2 (temperature)	B2	A (AUX probe) B (not used)
Temperature 2	B3 (temperature)	B3	Always present

Tab 4.b

4.8 Compressor time settings

The following is a list of all the time parameters used for compressor management (and not capacity control).

Time between stop requests with HP prevent active

Parameter C06 sets a stop delay between one compressor and the next, if the high pressure prevention (prevent) function is active. This applies both in the dead band and in the proportional band.

Minimum compressor ON time

Sets the minimum time the compressors stay on, that is, once activated, must remain on for the time set by this parameter (parameter C01).

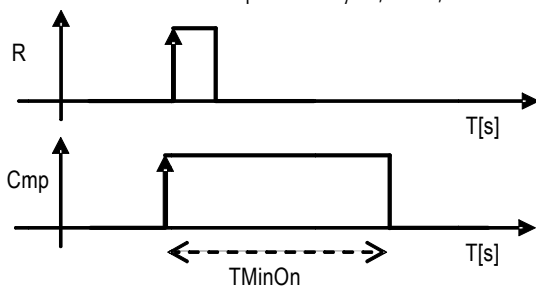

Key:

- R Compressor call
- Cmp Compressor
- TMinOn Minimum ON time
- T Time

Fig 4.f

Minimum compressor OFF time

Sets the minimum time the compressors stay off. The devices are not started again if the minimum time selected (parameter **C02**) has not elapsed since the last stop.

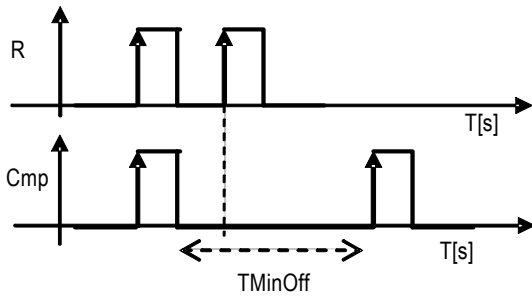

Fig. 4.g

Key:

- R Compressor call
- Cmp Compressor
- TMinOff Minimum OFF time
- T Time

Minimum time between starts of different compressors (proportional band)

This represents the minimum time that must elapse between the start of one device and the next. This parameter allows simultaneous starts to be avoided (parameter C03).

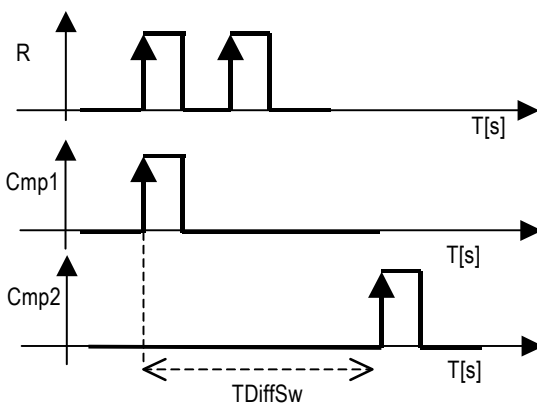

Fig 4.h

Key:

- R Compressor calls
- Cmp1 Compressor 1
- Cmp2 Compressor 2
- TDiffSw Minimum time between starts of different compressor
- T Time

With capacity control compressors is established fixed delay = 5 s, between a capacity control and the following.

Minimum time between starts of the same compressor

Sets the minimum time that must elapse between two starts of the same compressor.

This parameter limits the number of starts per hour. If, for example, the maximum allowable number of starts per hour is 10, to guarantee this limit simply set a value of 360 (parameter C05).

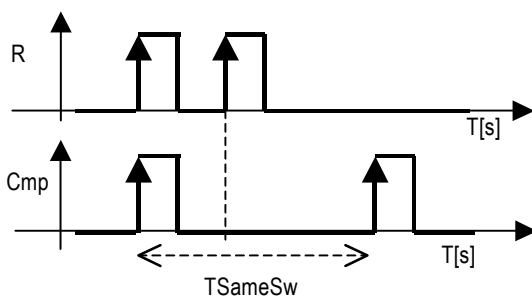

Fig 4.i

Key:

- R Compressor call
- Cmp Compressor
- TSameSw Minimum time between starts of the same compressor
- T Time

5 Fan and inverter management

Inputs used:

- Discharge pressure/temperature probe
- Digital inputs for the fan safety devices
- Multifunction input for generic alarm (general discharge pressure switch)

Outputs used:

- Condenser fan outputs
- Condenser fan speed control (PWM output)

5.1 Fan management

The operation of the fans depends on the value read by the discharge pressure (or temperature) sensor.

One thermal overload is featured for each fan step. This has a settable immediate reset and will only be valid for the specific fan. In the default configuration, "proportional band" control is set (parameter **r21**), and FIFO rotation (parameter **r20**).

5.1.1 Fan control

Proportional band

Proportional band control calculates, based on various parameters (SP, DF and the number of devices set) the points where the devices must switch on and off, inside the differential band.

Figure 5.1 shows the activation points for a system with 4 steps.

Setting the parameters listed above, each individual step will have a differential as follows:

$SP + 1 * DF / (\text{No. of steps})$ for the first;

$SP + 2 * DF / (\text{No. of steps})$ for the second;

...

$SP + DF$ for the last.

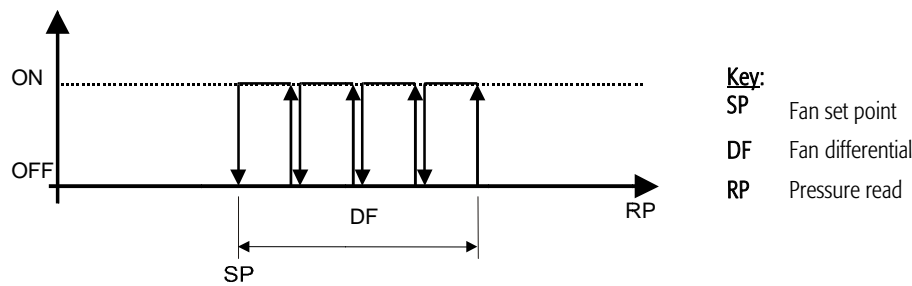

Fig. 5.a

5.2 Dead band control

This type of control features the definition of a dead band to the side of the set point, within which no device is started or stopped.

The devices are activated when the measured value exceeds the limit to the right (measured value greater than $SP + DZN$, see Figure 5.2). The number of devices to be activated varies according to the time elapsed outside of the dead band. The first device will start immediately, while the others will wait the set time between starts.

Similarly, the devices are stopped when the measured value falls below the dead band (measured value less than the set point), and remains there for a period equal to the time between device stop requests. In this case too, the first device stops immediately, while the others wait the delay time between stops.

The program will switch the devices on according to the start-up logic configured and the availability of the devices

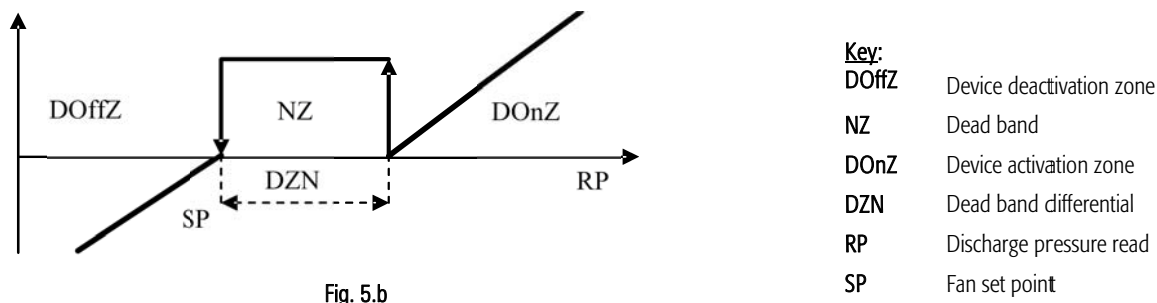

Fig. 5.b

Fan rotation

The rotation of the fans, settable by parameter **r20**, is aimed at balancing the number of operating hours and starts of the different fans.

Rotation automatically excludes any fans with active alarms.

If the fan is off for alarm or disabled, is excluded from regulation and rotation; the activation/deactivation thresholds are re-calculated based from actual number of fans available.

Two different types of rotation can be set:

LIFO rotation (no rotation parameter r20=0)

The first fan that to start will be the last to stop.

- Start: Fan1, Fan2, Fan3, Fan4.
- Stop: Fan3, Fan3, Fan2, Fan1.

FIFO rotation (parameter r20=1)

The first fan that to start will be the first to stop.

- Start: Fan1, Fan2, Fan3, Fan4.
- Stop: Fan1, Fan2, Fan3, Fan4.

The rotation of the fans is implemented when called.

Various fan parameters

In the event of a discharge probe fault or not connected alarm, parameter /12 sets the number of fans that are forced on.

5.3 Inverter management

The fan controller is enabled by parameter /10.

A minimum limit value can be set for the inverter (parameter r29), as a percentage.

To assist the start of the inverter, a time can be set, expressed in seconds, during which the inverter is forced on at 100% at startup before proceeding with the normal regulation. This parameter is called "Speed Up Time" (parameter r27).

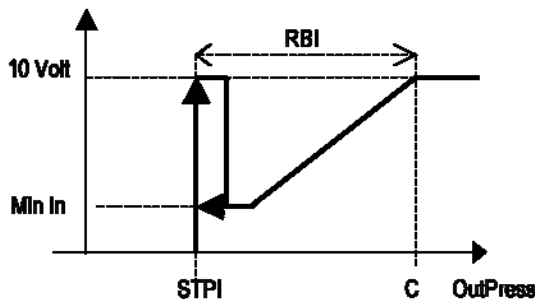

Key:

- STPI Fan inverter set point
- RBI Inverter differential
- Min In Minimum inverter opening
- C Fan set point + differential

Fig. 5.c

Management of the fans slaved to the compressors

Parameter "/13" defines whether the fans can be activated independently or whether at least one compressor must be on. This is used to prevent the condenser fans operating with high outside temperatures work when no compressor is operating. Typical application: cold rooms cold stores.

Parameter "/13" default = 0 (independent control).

Inverter control

Proportional band

This control requires the inverter set point STPI to be set (parameter r18), plus an inverter differential RBI (parameter r19).

If the value measured by the discharge probe is less than or equal to the value of the inverter set point, the inverter output will be 0.

Between the inverter set point STPI and point C (set point + differential), the value of the inverter output will be proportional to the value read by the discharge probe, and in any case not less than the minimum inverter output MinIn. If the value measured by the discharge probe is greater than or equal to the inverter set point + differential, the output will be at the maximum value. The control is not associated with any fan and can work without fans being configured.

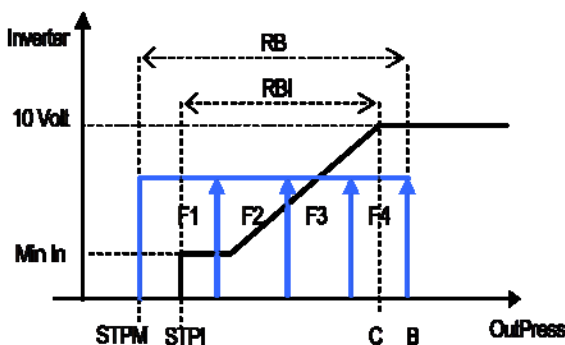

Key:

- RB Fan differential
- RBI Inverter differential
- STPM Discharge set point
- STPI Inverter set point
- C Inverter set point + inverter differential
- B Discharge set point + Fan differential
- Min In Minimum value of the inverter control output

Fig.5.d

Proportional control, set by parameter r21, may be proportional only (parameter r21=0) or proportional + integral (parameter r21=1).

Proportional and integral control (PI)

To minimise any deviations in stable operating conditions between the controlled value and the set point, typical of proportional control, a proportional plus integral strategy (P+I) can be used.

This strategy helps overcome situations of stalemate in which the working point remains steadily at a value other than the set point.

PI control adds the integral action to proportional control. This action, when a control error persists, has an increasing effect over time on the overall control action.

The parameter that defines the integral action is the integral time (r22).

The default value is 600 s (10 min). The integral time corresponds to the time taken by the integral action, **with a constant error**, to balance the proportional action.

The lower the integral time, the faster the response of the control.

For further information, refer to classic control theory.

N.B.: Make sure the integral time is not set too low, otherwise control may become unstable.

The following figure highlights the difference between the proportional control and proportional plus integral control (with inverter):

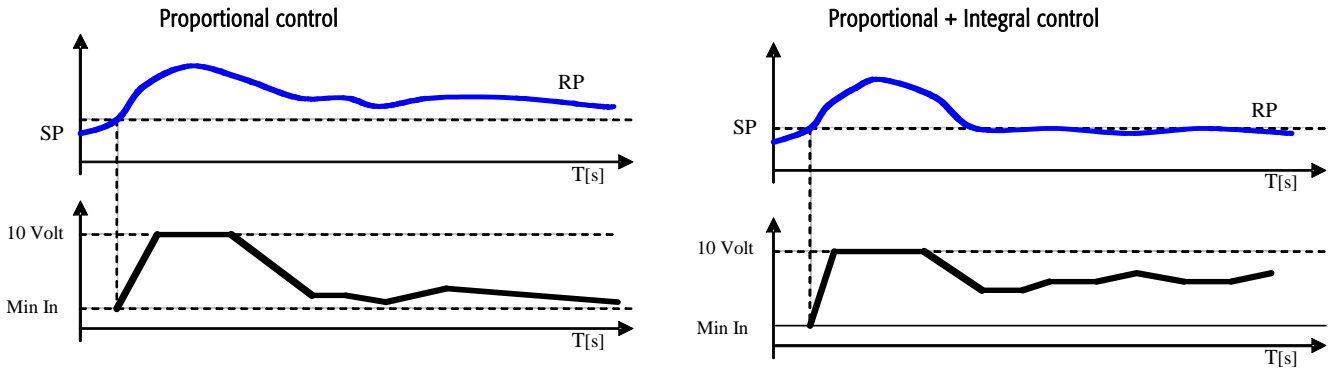

Fig. 5.e

Key:

RP	Pressure read
SP	Set point
T	Time
Min In	Minimum inverter output value

Dead band control

This control requires the setting of inverter set point, the inverter pressure differential for “dead band” control (parameter r21) and the “inverter ramp up time” (parameter r28).

Three zones are defined: activation zone **DOnZ**, dead band **NZ** and deactivation zone **DOffZ**, in which the program behaves differently (see the figure).

In the activation zone **DOnZ**, the fans are started as follows:

- The inverter is activated as soon as there is demand, with a value no less than the minimum inverter opening **MinIn**;
- The inverter output is increased according to the times set by parameter **r23**.
- If the inverter output reaches 100%, the situation persists

In the dead band **NZ**, the inverter output does not undergo any variation.

In the deactivation zone **DOffZ**, the fans are stopped as follows:

- The inverter output is progressively brought to the minimum value, according to the times set by parameter **r24**.
When reaching the minimum value, the fans are stopped.

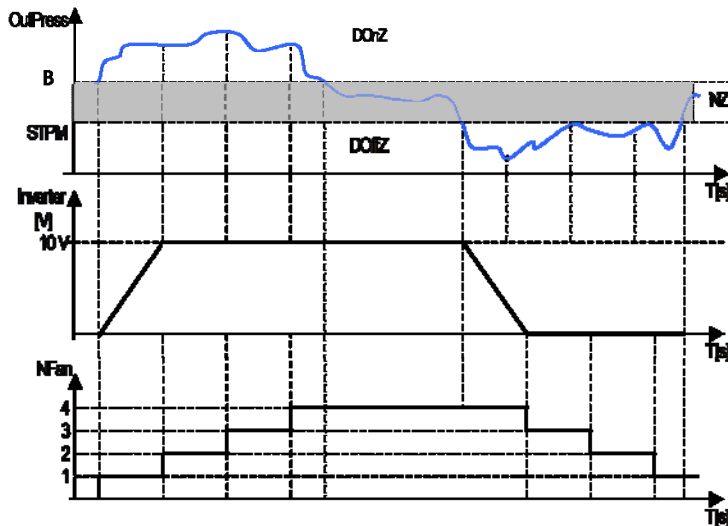

Fig. 5.f

Key:

InPress	Discharge pressure
B	Set point + differential
StpM	HP set point
DOnZ	Activation zone
DOffZ	Deactivation zone
NZ	Dead band
T [s]	Time
Inverter	Inverter status
NFan	Number of fans on

5.4 PWM-PPM management

On the controller, the “fan control” output generates a PWM signal.

This output is used to drive phase control modules that directly control the fan speed.

The output, depending on how it is configured, can generate a pulse width modulation (PWM) signal.

The example below shows two graphs representing the two modes.

In the graph, it can be seen that the request is 80% of the maximum value.

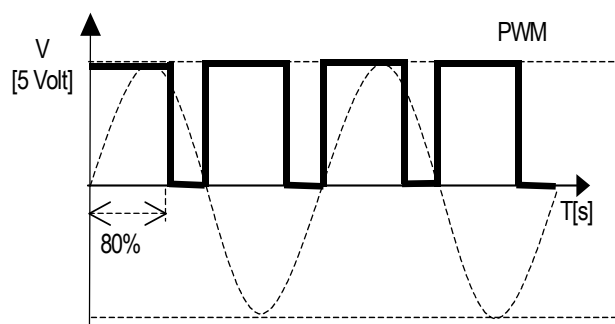

Fig. 5.g

The PWM signal controls, for example, the CAREL FCS* series, CONVONOFF, CONVO/10A0 modules.

ON/OFF fan control board (code CONVONOFF0)

The CONVONOFF0 modules convert the PWM signal sent from terminal Y to an ON/OFF signal. In practical terms, Y can be used to control a relay. Switching power 10A at 250 Vac in AC1 (1/3 HP inductive).

PWM to 0 to 10 Vdc (or 4 to 20 mA) conversion board for fans (code CONVO/10A0)

The CONVO/10A0 modules convert the PWM signal sent from terminal Y to a standard 0 to 10 Vdc (or 4 to 20 mA) signal.

Calculation of the minimum and maximum fan speed

This procedure should only be performed if fan speed control boards are used (code MCHRTF*0*0). It must be stressed that if the ON/OFF modules (code CONVONOFF0) or the PWM / 0 to 10 V converters (code CONVO/10A0) or FCS are used, the “Min. triac” parameter (r29) should be set to zero, and the “Max. triac” r30 parameter to the maximum value is the impulse period (r31)=0.

Given the range of different motors existing on the market, the voltages supplied by the electronic board that correspond to the minimum and maximum speed can be set. For this purpose (and if the default values are not suitable), proceed as follows:

1. Set the fan inverter to always On. Force inverter parameter, **M17**.
2. Set “Max triac” and “Min triac” to zero.
3. Increase “Max triac” until the fan operates at a speed considered sufficient (make sure that, after having stopped it, it starts rotating if left free);
4. “Copy” this value to the “Min triac” parameter; this sets the voltage corresponding to the minimum speed;
5. Connect a voltmeter (set for 250 V, AC) between the two “L” terminals (the two external contacts).
6. Increase “Max triac” until the voltage stabilises at around 2 Vac (inductive motors) or 1.6, 1.7 Vac (capacitive motors);
7. Once the optimum value is found, it should be seen that even when increasing “Max triac”, the voltage no longer decreases.
8. Do not increase “Max triac” any further, so as to avoid damaging the motor;
9. Set the force inverter parameter back to AUTO.

The operation is now complete.

5.5 Floating condenser control

If this function is enabled using parameter **r32**, the following parameters need to be set.

- a) DELTA T (**r33**) (condenser exchanger parameter, typically related to the type of condenser used)
- b) Minimum condensing pressure (**r25 in °C**)
- c) Maximum condensing pressure (**r26 in °C**)

The condenser set point is the value resulting from “DELTA T + Outside air temperature”, as with high outside temperatures the condensing temperature cannot be too low (no possibility of energy savings). This is used to optimise the operation of the fans. The maximum and minimum pressure values are the range in which floating control can operate.

ATTENTION: enabling this controller, the parameters “r16” (ventilation set) and “r18” (inverter ventilation set) are no more visible since the relevant set point become function of the external temperature + delta.

The following parameter are displayed in temperature always, not depending by used probe (pressure or temperature):

- r17 (Set the minimum value of suction probe)
- r19 (Fan inverter differential)
- r25 (Set the lower limit of the fan set point)
- r26 (I Set the upper limit of the fan set point)

6 Various settings

6.1 Manual device operation

The individual devices can be activated manually, ignoring the times and the rotation, and independently from the temperature control functions, by setting the related parameters **Mxx**.

The only support provided in manual operation is the alarm management function.

The manual activation of the speed controllers sets the corresponding outputs to the maximum value.

When even just one manual procedure is enabled, the "MANUFACTURER" icon on the display will FLASH!

If switching the board off and on again, the function is terminated.

Important: Use this function with care! Operating the devices manually may cause damage to the installation!

6.2 Compressor hour counter and maintenance alarm

Parameter **C07** is used to set the alarm threshold for the maintenance of the 4 compressors.

This parameter is expressed in the hundreds of hours, as the resolution of the display is only 3 digits.

Parameters **C08 C10 C12 C14** are used to check the number of operating hours of the compressors installed.

These parameters are also expressed in the tens of hours, as the resolution of the display is only 3 digits.

Parameters **C09 C11 C13 C15** are used to reset each individual hour counter.

The compressor maintenance alarm is shown by an alarm code, as well as by the simultaneous activation of the Maintenance and Alarm icons.

6.3 Set point variation from digital input

This function is useful when needing to increase or decrease the set point during night-time operation.

An offset is added to the compressor set point when the multifunction input, set for this function, is closed.

The offset can be defined using parameter **R34**.

6.4 Type of refrigerant

By selecting the type of refrigerant used in the installation (parameter /35), the software will automatically calculate the conversion of the pressure to temperature.

The following table lists the types of gas managed:

Refrigerant	Complete name
R134a	Tetrafluoroethane
R290	Propane
R600	Butane
R600a	2-methyl propane (isobutane)
R717	Ammonia (NH3)
R744	Carbon dioxide (CO2)
R404A,R407C,R410A,R507C	Mixes of gases

Tab. 6.a

6.5 Auxiliary probe management

The software can manage two auxiliary temperature probes, in addition to the suction and discharge probes.

The two probes can be configured with parameters /21 and /22:

No.	Channel	NTC probe
1	B2	-room temperature probe, read-only -auxiliary probe
2	B3	-outside temperature probe for <u>Floating condenser control</u> -auxiliary probe

Tab. 6.b

If the auxiliary probe selected, a high temperature threshold can be set (parameter **A16, A17**). This alarm has automatic reset, with a fixed differential of 2°C.

Example of HT alarm management

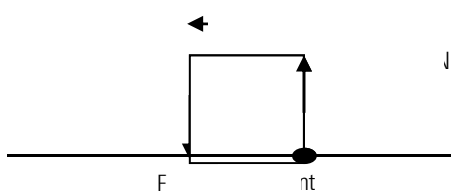

Fig. 6.a

6.6 Prevent high discharge pressure

This function is enabled by parameter /32.

In order to prevent the activation of the general high pressure switch (total shutdown of the compressors, with manual reset), a "prevention" function can be enabled by setting a pre-alarm threshold; this function gradually decreases the capacity of the unit.

The high pressure prevention (Prevent HP) function is only enabled during the activation and deactivation of the compressors.

If the discharge pressure exceeds the threshold set (parameter /33), the activation of any compressors is disabled and a prevent alarm is generated. In addition, all the compressor load steps are deactivated, observing the times set for parameter C06.

If the discharge pressure falls below the Prevent threshold, any other compressor start calls are ignored, for a set time called Prevent time 1 (parameter A13).

If between the start of two prevent cycles a time less than Prevent time 2 (parameter A14) elapses, the "Excessive prevent frequency" alarm is generated, A29.

The "Excessive prevent frequency" alarm (display only) is reset automatically, if, within Prevent time 3 (parameter A15), the prevent function is not activated again. This alarm can be reset manually by the user, momentarily disabling the PREVENT function, using parameter /32.

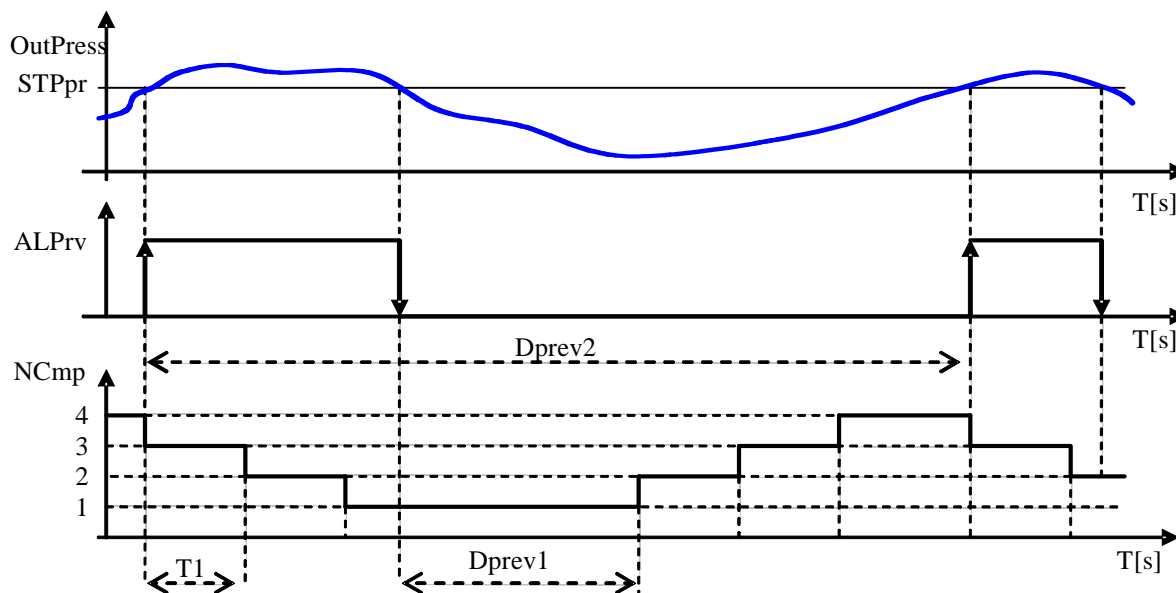

Fig. 6.b

Key:	
OutPress	Discharge pressure
T	Time
NCmp	Number of suction steps required
ALPrv	High pressure prevention alarm
STPpr	Prevent HP activation threshold
T1	Time between compressor stops with prevent HP active
Dprev1	Step activation delay after end prevent HP (prevent time 1)
Dprev2	Minimum time for activation of high prevent frequency alarm (prevent time 2)

7 Alarm management

The activation of an alarm, from digital input, causes the direct action on the devices involved, at the same time activating: the LED and a signal on the display. If the compressors are called, the activation of an alarm on one compressor sends the call to another compressor.

The alarm information appears is displayed alternating with the value read by the control probe. If more than one alarm is active, the information appears on the display in sequence. If the alarm situation is resolved, the relay is reset and the alarm message is cancelled. In the case of alarms with manual reset, the Reset Alarms parameter (A19) needs to be accessed.

The alarm from digital input is typically detected when the contact “opens”, however the logic can be selected using the “digital input logic” parameter, /14.

7.1 Alarms with automatic reset

When one or more automatic reset alarms are detected, these are signalled by:

- Red **ALARM** LED on;
- Alarm relay changes, if enabled.

Press the PRG/MUTE button.

If the cause of the alarms is resolved, the devices that have shutdown will restart normal operation, and the status of the signal devices changes as follows:

- The alarm relay changes to normal status;
- Red **ALARM** LED goes off..

If, in this situation, new alarms are activated, the initial situation will return.

The signal will remain active to leave a sign of alarm ON, until the operator manually sets the reset alarms parameter A19.

7.2 Alarms with manual reset

The compressor thermal overload (parameter /29) fan thermal overload (parameter /30) alarms can be set as manual reset.

When one or more manual reset alarms are detected, these are signalled by:

- Red **ALARM** LED on;
- Alarm relay changes, if enabled.

If the cause of the alarms has been resolved, the red LED stays on to inform the user that alarms have been activated during the day. In this situation, the alarm relay remains in an alarm condition and the devices remain disabled until the user deleted the alarm messages using parameter A19.

If, in this situation, new alarms are activated, the initial situation will return..

If the causes no longer exist, the status of the signal devices changes as follows:

- The alarm relay changes to normal status;
- Red **ALARM** LED goes off..

If, on the other hand, the cause of the alarms is still present, the initial situation will return.

7.3 Semiautomatic alarms

The low pressure alarm from transducer is a semiautomatic alarm. It acts as an alarm with automatic reset, however if it is activated at least 3 times within a set time (default 10 minutes), it becomes an alarm that must be reset manually, that is, using parameter A19. This alarm obviously causes the unit to shutdown.

7.4 Alarm relay

Based on the configuration (no. of devices < 5) relay no. 5 (multifunction) can be used as an alarm relay.

A delay time can be set (parameter A20) between the activation of an alarm and the change in the status of the signal relay.

If the time is set to 0, the activation of the alarm relay is immediate.

Code	Alarm description	Generated by	Action performed	Type of reset	Delay	Notes
A01	Compressor 1	DIN	Comp.1 OFF	Settable	Settable	
A02	Compressor 2	DIN	Comp.2 OFF	Settable	Settable	
A03	Compressor 3	DIN	Comp.3 OFF	Settable	Settable	
A04	Compressor 4	DIN	Comp.4 OFF	Settable	Settable	
A05	Compressor 1 maintenance	---	/	Settable	no	
A06	Compressor 2 maintenance	---	/	Settable	no	
A07	Compressor 3 maintenance	---	/	Settable	no	
A08	Compressor 4 maintenance	---	/	Settable	no	
A09	Liquid level (from multifunction input)	DIN	/	manual	settable	
A10	General suction pressure switch 1 (from multifunction input)	DIN	COMP OFF CIRC 1	automatic	no	
A11	General suction pressure switch 2 (from multifunction input)	DIN	COMP OFF CIRC 2	automatic	no	
A12	General discharge pressure switch (from multifunction input)	DIN	All comps. OFF	Settable	no	
A13	Low discharge pressure	AIN	All fans OFF	automatic	settable	

Code	Alarm description	Generated by	Action performed	Type of reset	Delay	Notes
A14	High discharge pressure	AIN	All fans ON	automatic	no	
A15	Low suction pressure 1	AIN	All comps. OFF	automatic	settable	
A16	High suction pressure 1	AIN	all comps. ON	automatic	settable	
A17	Low suction pressure 2	AIN	All comps. OFF	automatic	settable	
A18	High suction pressure 2	AIN	all comps. ON	automatic	settable	
A19	Suction probe 1 faulty or disconnected	AIN	Settable no. comps. ON	automatic	30 seconds	See compressor management with probe broken.
A20	Suction probe 2 faulty or disconnected	AIN	Settable no. comps. ON	automatic	30 seconds	See compressor management with probe broken.
A21	Discharge probe faulty or disconnected	AIN	Settable no. fans ON	automatic	30 seconds	Force fan inverter to 100%.
A22	Fan 1 thermal overload	DIN	Fan 1 OFF	Settable	no	
A23	Fan 2 thermal overload	DIN	Fan 2 OFF	Settable	no	
A24	Fan 3 thermal overload	DIN	Fan 3 OFF	Settable	no	
A25	Fan 4 thermal overload	DIN	Fan 4 OFF	Settable	no	
A26	General fan thermal overload	DIN	Only signal alarm. Preset electronically the fan stop during overload	Automatic	no	
A27	Prevent high discharge pressure	AIN	Compressors OFF	Automatic	no	
A28	Compressors off for Prevent HP	AIN	Compressors OFF	Automatic	no	
A29	Excessive prevent frequency	AIN	/	Settable	no	Display only
HtE	High outside temperature	AIN		Automatic	No	
HtA	High ambient temperature	AIN		Automatic	No	
EHS	High supply voltage	---	OFF	Automatic	No	
ELS	Low supply voltage	---	---	Automatic	No	
EPb	EEPROM error	---	---	Settable	No	
EL1	Zero cross	Power supply voltage	100% Fans	Automatic	No	
AB2	B2 probe error faulty or disconnected	AIN	---	Automatic	No	
AB3	B3 probe error faulty or disconnected	AIN	---	Automatic	No	

Tab. 7.a

7.5 Alarms from analogue inputs: temperature probe and pressure transducer:

Fixed differentials: 0.2 bar suction
1.0 bar discharge

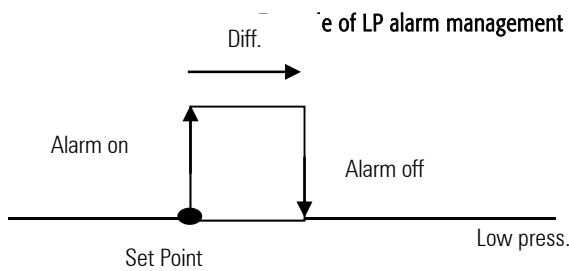

Fig. 7.a

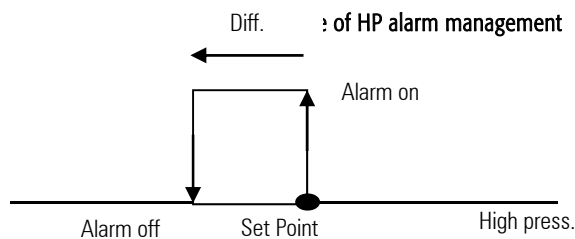

Fig. 7.b

8 The supervisor network

μRack can be connected to the most common supervisory systems, using suitable interface boards and protocols.

In particular, the following data is exchanged with the supervisor:

- The status of the inputs /outputs
- The status of the devices enabled
- Alarms present and active
- Enabling of the devices, various settings etc.

In addition, this function allows the possibility to modify a series of parameters from the supervisor, such as: set point, differentials, times, unit status, reset alarms etc. Also see the paragraph Supervisor communication variables.

8.1 Serial boards

For connection to supervisory systems, the control uses the standard CAREL RS485 serial protocol.

Serial connection options:

Product code	RS485 serial option Code	Notes
MRK0000000	MCH2004850	External option connected by cable to μRack compact
MRK00000D0	FCSER00000	Serial output board for DIN version, to be fitted in the instrument
MRK0000AD0	-----	μRack with serial option FCSE00000 already FITTED by CAREL

Tab. 8.a

8.2 Communication protocols

Communication protocol: CAREL.

To enable the correct operation of the communication protocol, as well as installing the board, a number of parameters need to be set, such as the identification number (parameter /36).

Each controller must have the address set so that:

- There are NO other devices with the same address on the same serial line
- The addresses on the same serial line must be set in progressive order, starting from 1.

For further information, refer to the corresponding manual or contact CAREL.

9 User interface

The parameters are divided into 2 categories.

Display information that is **NOT password-protected**: show the values of the probes, alarms.

Display information that is **password-protected**:

1. **USER** parameters (password 22 modifiable by parameter /40): set the main functions of the devices connected (times, set points, differentials);
2. **INSTALLER** parameters (password 44 modifiable by parameter /41): periodical checks on the devices, calibration of the probes connected, manual operation of the devices.
3. **MANUFACTURER** parameters (password 77 modifiable by parameter /42): configure the compressor rack, enable the main functions and select the devices connected.

Once the password is entered, it remains in the memory until automatically returning to the main screen, so as to make it easier to move around within the same level of protection.

IMPORTANT:

To change the level of parameter protection from the keypad (from the MANUFACTURER level only), proceed as follows:

1. Once having entered the correct PWD MANUFACTURER, the system displays the string "S-P" (Set Parameters);
2. Then either press "SEL", directly accessing the parameter menu to change the values or press "DOWN" or "UP" to display of the string "L-P" (Level-Parameters).
3. If modifying the level, pressing "SEL" accesses the parameter menu as described, where parameters are scrolled no longer displayed with the associated value, but rather the level of protection.
4. Using the same procedure as for modifying the parameters, change the level, choosing between the 3 possible levels available:

"_U_" :parameters visible at User level,

"_I_" :parameters visible at Installer level,

"_C_" :parameters visible at Manufacturer level.

10 List of parameters

This table contains the list of all the parameters, with the corresponding description.

Parameter: description;

Type: (R) read-only, (R/W) read/write;

Pos.: position: USER-INSTALLER-MANUFACTURER;

Description: synthetic description of the parameter;

UOM: unit of measure of the value in question;

Range: range of possible values for the parameter;

Default: factory-set value of the parameter.

Notes: column available for user notes.

IMPORTANT: Not all the screens listed below will be displayed when scrolling the display; enabling a certain type of configuration will mean that new screens are displayed that were previously not available. The display therefore depends on the initial configuration!

USER PARAMETERS			Sel	Press the SEL button for at least 5 secs		PW 22		
INSTALLER PARAMETERS			Prg <i>mute</i>	Press the button PRG per at least 5 secs		PW 44		
MANUFACTURER PARAMETERS			Prg <i>mute+Sel</i>	Press the PRG + SEL button together for more than 5 seconds THIS PASSWORD OFFERS THE POSSIBILITY OF DISPLAYING ALL THE PARAMETERS FOR PROGRAMMING THE UNIT AND CHANGING THE LEVEL OF PROTECTION:		PW 77		

Tab. 10.a

Structure of the parameters:

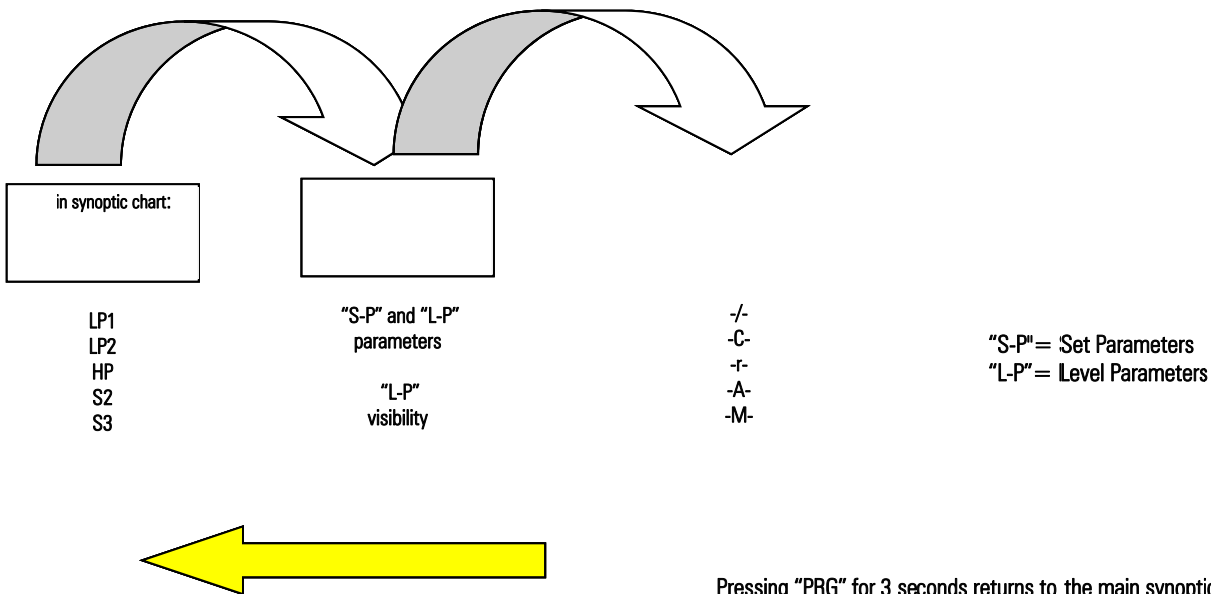

Fig. 10.a

Table of parameters

Parameter	Type	Pos.	Display	Description	UOM	Range	Default	Notes
Configuration menu								
Type of unit	R/W	C	/00	Set the type of unit, LT, MT or two circuit 0) LT 1) MT 2) TWO CIRCUIT		0 to 2	0	

Parameter	Type	Pos.	Display	Description	UOM	Range	Default	Notes
Unit model	R/W	C	/01	Set the unit model (without capacity control): SINGLE CIRCUIT 0) 0 compressors 1) 1 compressor 2) 2 compressors 3) 3 compressors 4) 4 compressors TWO CIRCUIT 5) 1 compressor + 1 compressor 6) 2 compressors + 1 compressor 7) 3 compressors + 1 compressor 8) 2 compressors + 2 compressors Set the unit model (with capacity control): SINGLE CIRCUIT 9) 1 compressor 1 capacity control 10) 1 compressor 2 capacity control 11) 1 compressor 3 capacity control TWO CIRCUIT 12) 1 compressor 1 capacity control + 1 compressor 13) 1 compressor 1 capacity control + 1 compressor 1 capacity control 14) 1 compressor 2 capacity control + 1 compressor		0... 14	2	
Compressors with different capacities	R/W	C	/02	Enable management of compressors with different capacities 0) NOT ENABLED 1) ENABLED		0/1	0	For single circuit only for the configuration /01=1,2,3 e 4
Capacity compressor 1	R/W	C	/03	Capacity of compressor 1	kW	0 to 999	5	Only if comp. with different capacities are enabled
Capacity compressor 2	R/W	C	/04	Capacity of compressor 2	kW	/03 to 999	10	Only if comp. with different capacities are enabled
Capacity compressor 3	R/W	C	/05	Capacity of compressor 3	kW	/03+/04 to 999	20	Only if comp. with different capacities are enabled
Capacity compressor 4	R/W	C	/06	Capacity of compressor 4	kW	/03+/04+/05 to 999	40	Only if comp. with different capacities are enabled
Number of compressors ON with suction probe 1 fault	R/W	C	/07	If the suction 1 probe fault or not connected alarm is activated, this number of compressors are started. These are in any case managed by the individual alarms and general pressure switches.		0 to 4	0	Number limited by the number of compressors
Number of compressors ON with suction probe 2 fault	R/W	C	/08	If the suction 2 probe fault or not connected alarm is activated, this number of compressors are started. These are in any case managed by the individual alarms and general pressure switches.		0... 2	0	For two circuits only
Configure number of fans	R/W	C	/09	Set the number of fans		0 to 4	2	Number limited by the number of compressors already enabled
Enable fan inverter	R/W	C	/10	Enable control of the fans with inverter		0/1	0	
Display inverter output value	R	U	/11	Display the inverter output as a percentage		0 to 100%	0	
Number of fans ON with probe fault:	R/W	C	/12	If the discharge probe fault or not connected alarm is activated, this number of fans are started. These are in any case managed by the individual alarms and general pressure switches..		0 to 4	0	
Enable fans with compressors ON	R/W	C	/13	0= independent operation of the fans 1= fans on only when at least one compressor is ON		0/1	0	
Digital input logic: N.O. =No alarm	R/W	C	/14	Set the logic of the digital inputs. 0) N.O.: with no alarm the contact is open 1) N.C. : with no alarm the contact is closed		0/1	1	NO / NC
Multifunction input configuration	R/W	C	/15	Set the type of multifunction input: 0: no function 1) unit ON-OFF (NC contact ON) 2) change set point (set1- set2) 3) general high pressure switch NC 4) general high pressure switch NO 5) general low pressure switch 1 NC 6) general low pressure switch 1 NO 7) general low pressure switch 2 NC 8) general low pressure switch 2 NO 9) liquid level alarm NC 10) liquid level alarm NO 11) general fan thermal overload NC 12) general fan thermal overload NO		0 to 12	0	If the 4 outputs are used, this parameter is ignored and the Multifunction Input is set as fan thermal overload
B1 probe type	R/W	C	/16	B1 probe set: 0) probe not connected 1) NTC probe 2) 0 to 5 V probe		0 to 2	2	
MIN suction pressure	R/W	C	/17	Set the minimum value of suction probe	bar	-1.0 to /19	-1.0	

Parameter	Type	Pos.	Display	Description	UOM	Range	Default	Notes
MIN discharge/suction 2 pressure	R/W	C	/18	Set the minimum value of discharge probe/suction probe of second circuit	bar	-1.0 to /20	0	
MAX suction pressure	R/W	C	/19	Set the maximum value of the suction probe	bar	/17 to 45.0	9.3	
MAX discharge/suction 2 pressure	R/W	C	/20	Set the maximum value of the discharge probe/suction probe of second circuit	bar	/18 to 45.0	34.5	
B2 probe type	R/W	C	/21	B2 probe set: 0) probe not connected 1) ambient air temp. probe / for two circuit, condenser probe 2) auxiliary temperature probe (used for HT alarm)		0 to 2	0	
B3 probe type	R/W	C	/22	B3 probe set: 0) probe not connected 1) outside air temp. probe 2) auxiliary temperature probe (used for HT alarm)		0 to 2	0	
B4 probe calibration (suction)	R/W	I	/23	Suction probe calibration	bar	-12 to 12	0	
B1 Probe calibration (discharge)	R/W	I	/24	Discharge probe calibration	bar	-12 to 12	0	
B2 probe calibration	R/W	I	/25	Room probe calibration	°C	-12 to 12	0	
B3 probe calibration	R/W	I	/26	Outside probe calibration	°C	-12 to 12	0	
Display probe	R/W	U	/27	Probe displayed as default 0) probe B1 1) probe B2 2) probe B3 3) probe B4		0 to 3	3	
Alarm relay logic	R/W	C	/28	Logic of the alarm relay 0) NC 1) NO		0/1	1	If alarm relay enabled
Type of compressor thermal overload alarm reset	R/W	C	/29	Type of thermal overload/generic alarm reset relating to the individual compressor. Automatic: when the alarm stops, the compressor starts again. Displayed only if the parameters are enabled 0) AUTO 1) MANUAL		0/1	1	
Type of fan thermal overload alarm reset	R/W	C	/30	Type of thermal overload/generic alarm reset relating to the individual fan. Automatic: when the alarm stops, the fan starts again. Displayed only if the parameters are enabled 0) AUTO 1) MANUAL		0/1	1	
Type of general discharge pressure switch reset	R/W	C	/31	Type of general high pressure switch reset 0) AUTO 1) MANUAL		0/1	0	
Prevent high discharge pressure	R/W	C	/32	Enable high discharge pressure prevention		0/1	0	
Set point	R/W	C	/33	High discharge pressure prevention set point	bar	0 to 45.0	18.0	If prevent enabled
Refrigerant conversion	R/W	C	/35	Type of refrigerant used 0) No refrigerant 1) R22 2) R134a 3) R404a 4) R407c 5) R410a 6) R507 7) R290 8) R600 9) R600a 10) R717 11) R744		0 to 11	3	
Serial address	R/W	C	/36	Supervisor configuration. Identification number of the μRack board for the supervisor serial network		1 to 200	1	
Delay restart after black out	R/W	I	/37	Enable delay at start-up after a black out, with the set time. If 0 no delay	s	0 to 999	0	
Unit ON/OFF from the supervisor	R/W	I	/38	Enable/disable unit from the supervisor. 0) OFF 1) ON		0/1	1	
Unit ON/OFF by parameter	R/W	U	/39	Enable/disable unit by parameter 0) OFF 1) ON		0/1	1	
New User password	R/W	U	/40	Used to change the password to access the User branch		0 to 999	22	
New Installer password	R/W	I	/41	Used to change the password to access the Installer branch		0 to 999	44	
New Manufacturer password	R/W	C	/42	Used to change the password to access the Manufacturer branch		0 to 999	77	
B4 probe type	R/W	C	/43	B4 probe set: 0) probe not connected 1) 0 to 5 V probe 2) 0 to 5 V probe		0 to 2	2	

Parameter	Type	Pos.	Display	Description	UOM	Range	Default	Notes
Compressor menu								
Min. compressor ON time	R/W	C	C01	Minimum ON time for same compressor	s	0 to 999	10	
Min. compressor OFF time	R/W	C	C02	Minimum OFF time for same compressor	s	0 to 999	120	
Min. time between starts of different compressors	R/W	C	C03	Minimum time between two start calls for different compressors. Avoids simultaneous starts	s	0 to 999	30	
Min. time between stops of different compressors	R/W	C	C04	Minimum time between two stop calls for compressors	s	0 to 999	10	
Min. time between starts of same compressor	R/W	C	C05	Minimum time between two effective starts of the same compressor	s	0 to 999	360	
Time between compressor OFF call with prevent active	R/W	C	C06	Time between compressor stop call with high pressure prevention active	s	0 to 999	30	Only if prevent active
Compressor operating hour threshold for maintenance alarm	R/W	I	C07	Compressor operating hour threshold for maintenance alarm. If set to 0, no maintenance alarms.	h x 100	0 to 320	0	
Compressor 1 operating hours	R	I	C08	Display compressor 1 operating hours	h x 100	0 to 320	0	
RESET Compressor 1 operating hours	R/W	I	C09	Reset compressor 1 operating hours 0) NO RESET 1) RESET		0/1	0	
Compressor 2 operating hours	R	I	C10	Display compressor 2 operating hours	h x 100	0 to 320	0	
RESET Compressor 2 operating hours	R/W	I	C11	Reset compressor 2 operating hours 0) NO RESET 1) RESET		0/1	0	
Compressor 3 operating hours	R	I	C12	Display compressor 3 operating hours	h x 100	0 to 320	0	
RESET Compressor 3 operating hours	R/W	I	C13	Reset compressor 3 operating hours 0) NO RESET 1) RESET		0/1	0	
Compressor 4 operating hours	R	I	C14	Display compressor 4 operating hours	h x 100	0 to 320	0	
RESET Compressor 4 operating hours	R/W	I	C15	Reset compressor 4 operating hours 0) NO RESET 1) RESET		0/1	0	
Control menu								
Compressor set point circuit 1	R/W	U	r01	Compressor set point first circuit	bar / °C	r12 to r13	1.0	
Compressor differential circuit 1	R/W	U	r02	Compressor differential first circuit	bar / °C	0 to 20.0	0.5	
Compressor set point circuit 2	R/W	U	r03	Compressor set point second circuit	bar / °C	r14 to r15	1.0	For two circuits only
Compressor differential circuit 2	R/W	U	r04	Compressor differential second circuit	bar / °C	0 to 20.0	0.5	For two circuits only
Compressor rotation	R/W	C	r05	Type of compressor rotation		0 = No rotation 1 = FIFO 2 = Time	1	For single circuit only
Compressor control	R/W	C	r06	Type of compressor control: 0) Proportional 1) Dead band 2) Dead band with time		0/2	1	
Min call time start in dead band	R/W	I	r07	Set minimum call time for compressor starts in dead band	s	C03 to r08	20	Only if dead band control is enabled
Max call time start in dead band	R/W	I	r08	Set maximum call time for compressor starts in dead band	s	r07 to 999	60	Only if dead band control is enabled
Min call time stop in dead band	R/W	I	r09	Set minimum call time for compressor stops in dead band	s	0 to r10	10	Only if dead band control is enabled
Max call time stop in dead band	R/W	I	r10	Set maximum call time for compressor stops in dead band	s	0 to 999	60	Only if dead band control is enabled
Dead band differential pressure in which the time varies	R/W	I	r11	Pressure differential in which the compressor start/stop time is proportional to the suction pressure	bar	/17...20,0	0.5	Only if dead band control is enabled
Min compressor set point	R/W	C	r12	Set the lower limit of the compressor set point circuit 1	bar	/17 to r13	0.1	
Max compressor set point	R/W	C	r13	Set the upper limit of the compressor set point circuit 1	bar	r12 to /19	9.3	
Min compressor set point circuit 2	R/W	C	r14	Set the lower limit of the compressor set point circuit 2	bar	/18 to r15	0.1	For two circuits only
Max compressor set point circuit 2	R/W	C	r15	Set the upper limit of the compressor set point circuit 2	bar	r14 to /20	10	For two circuits only
Fan set point	R/W	U	r16	Fan set point	bar °C	r25 to r26	15.5 35.7	For single circuit only
Fan differential	R/W	U	r17	Fan differential	bar °C	0 to 20.0 0 to 20.0	3 18	For single circuit only
Inverter set point	R/W	U	r18	Fan inverter set point	bar °C	r25 to r26	15.5 35.7	Only if the inverter is enabled

Parameter	Type	Pos.	Display	Description	UOM	Range	Default	Notes
Fan inverter differential	R/W	U	r19	Fan inverter differential	bar °C	0 to 20.0 0 to 20.0	3 18	Only if the inverter is enabled
Fan rotation	R/W	C	r20	Type of fan rotation. 0) NO ROTATION 1) FIFO		0/1	1	For single circuit only
Fan control	R/W	C	r21	Type of fan control: 0) Proportional 1) Proportional + integral 2) Dead band		0 to 2	0	For single circuit only
Integral time (P+I only)	R/W	C	r22	Integral time with P+I control	s	0 to 999	600	Only if PI
Time between fan start call	R/W	C	r23	Minimum time between two successive calls to start different fans	s	0 to 999	2	xx
Time between fan stop call	R/W	C	r24	Minimum time between two successive calls to stop different fans	s	0 to 999	2	xx
Min fan set point	R/W	C	r25	Set the lower limit of the fan set point	bar °C	0 to r26 -50 to r26	1.0 -31.2	
Max fan set point	R/W	C	r26	Set the upper limit of the fan set point	bar °C	r25 to 40.0 r25 to 150	25.0 55.3	
Fan inverter speedup time	R/W	C	r27	Fan inverter speedup time	s	0 to 999	2	Only if the inverter is enabled
Inverter ramp up time	R/W	I	r28	Set the time taken by the inverter to reach full load	s	0 to 999	10	Only if the inverter is enabled
Minimum fan inverter output	R/W	C	r29	Set the minimum operation of the fan inverter	%	0 to r30	0	Only if the inverter is enabled
Maximum fan inverter output	R/W	C	r30	Set the maximum operation of the fan inverter	%	r29 to 100	100	Only if the inverter is enabled
Triac impulse duration	R/W	C	r31	Duration of the impulse applied to the triac	ms	0 to 10	0	Only if the inverter is enabled
Enable floating condenser control	R/W	C	r32	Enable the floating condenser control 0) NO 1) YES		0 to 1	0	
Condensing Delta T	R/W	C	r33	Temperature difference for floating condenser control		-40 to 150	10	
Compressor management offset set point	R/W	I	r34	Compressor bar auxiliary set point offset. Used when changing the set point from digital input		-99.9 to 99.9	0	
Alarm menu								
HP suction 1 alarm	R/W	I	A01	Suction probe 1 alarm: high threshold setting	bar	A03 to /19	9.3	
HP suction 1 delay	R/W	I	A02	Suction probe 1 alarm: delay setting	s	0 to 999	60	
LP suction 1 alarm	R/W	I	A03	Suction probe 1 alarm: low threshold setting	bar	/17 to A01	0	
LP suction 1 delay	R/W	I	A04	Suction probe alarm: delay setting	s	0 to 999	60	
HP suction 2 alarm	R/W	I	A05	Suction probe 2 alarm: high threshold setting	bar	A07.../20	9.3	For two circuits only
HP suction 2 delay	R/W	I	A06	Suction probe 2 alarm: delay setting	s	0 to 999	60	
LP suction 2 alarm	R/W	I	A07	Suction probe 2 alarm: low threshold setting	bar	/18 to A05	0	For two circuits only
LP suction 2 delay	R/W	I	A08	Suction probe alarm: delay setting	s	0 to 999	60	
HP discharge alarm	R/W	I	A09	Discharge probe alarm: high threshold setting	bar °C	A10 to /20 A10 to 150	20.0 45.8	
LP discharge alarm	R/W	I	A10	Discharge probe alarm: low threshold setting	bar °C	/18 to A09 -50 to A09	0 -50	
Discharge delay	R/W	I	A11	Discharge probe alarm: delay setting	s	0 to 999	60	
Compressor thermal delay	R/W	I	A12	Compressor thermal overload alarm: delay setting	s	0 to 999	0	
HP prevention Prevent time 1	R/W	I	A13	Time in which start calls are ignored after prevent HP	m	0 to 99	5	Only if the prevent is enabled
HP prevention Prevent time 2	R/W	I	A14	If two prevent alarms occur within this time, an excessive prevent frequency alarm is generated	m	0 to 999	6	Only if the prevent is enabled
HP prevention Prevent time 3	R/W	I	A15	If no prevent alarms occur in this period, the high prevent frequency alarm is automatically reset	m	0 to 99	30	Only if the prevent is enabled
High temp. probe threshold: B2	R/W	I	A16	High temperature threshold, probe B2	°C	-40 to 150	100	
High temp. probe threshold: B3	R/W	I	A17	High temperature threshold, probe B3	°C	-40 to 150	100	
Delay liquid level alarm	R/W	I	A18	Set the liquid level alarm delay from multifunction input	m	0 to 500	60	
Reset ALARMS	R/W	U	A19	Reset the alarms with manual reset 0) NO RESET 1) RESET		0/1	0	
Alarm signal delay	R/W	I	A20	Set alarm signal delay	s	0 to 999	1	
Exchange auto->man LP 3 alarms	R/W	I	A21	On the 3rd activation, within the set time, the low pressure alarm from pressure switch changes from automatic to manual reset.	m	0 to 999	10	
OFF due to probe disconnected	R/W	I	A22	Enable unit OFF due to probe disconnected/alarm 0) NO 1) YES		0/1	0	
Maintenance menu								

Parameter	Type	Pos.	Display	Description	UOM	Range	Default	Notes
Enable compressor 1	R/W	1	M01	Enable operation of compressor 1 in automatic mode: 0) NO 1) YES		0/1	1	
Enable compressor 2	R/W	1	M02	Enable operation of compressor 2 in automatic mode: 0) NO 1) YES		0/1	1	
Enable compressor 3	R/W	1	M03	Enable operation of compressor 3 in automatic mode: 0) NO 1) YES		0/1	1	
Enable compressor 4	R/W	1	M04	Enable operation of compressor 4 in automatic mode: 0) NO 1) YES		0/1	1	
Force compressor 1	R/W	1	M05	Manually operate compressor 1 0) NO 1) YES		0/1	0	
Force compressor 2	R/W	1	M06	Manually operate compressor 2 0) NO 1) YES		0/1	0	
Force compressor 3	R/W	1	M07	Manually operate compressor 3 0) NO 1) YES		0/1	0	
Force compressor 4	R/W	1	M08	Manually operate compressor 4 0) NO 1) YES		0/1	0	
Enable fan 1	R/W	1	M09	Enable operation of fan 1 in automatic mode: 0) NO 1) YES		0/1	1	
Enable fan 2	R/W	1	M10	Enable operation of fan 2 in automatic mode: 0) NO 1) YES		0/1	1	
Enable fan 3	R/W	1	M11	Enable operation of fan 3 in automatic mode: 0) NO 1) YES		0/1	1	
Enable fan 4	R/W	1	M12	Enable operation of fan 4 in automatic mode: 0) NO 1) YES		0/1	1	
Force fan 1	R/W	1	M13	Manually operate fan 1 0) NO 1) YES		0/1	0	
Force fan 2	R/W	1	M14	Manually operate fan 2 0) NO 1) YES		0/1	0	
Force fan 3	R/W	1	M15	Manually operate fan 3 0) NO 1) YES		0/1	0	
Force fan 4	R/W	1	M16	Manually operate fan 4 0) NO 1) YES		0/1	0	
Force inverter	R/W	1	M17	Manually operate the inverter at 100% 0) NO 1) YES		0/1	0	Only if the inverter is disabled

Tab. 10.b

11 ON/OFF fan control board (code CONVONOFF0)

The CONVONOFF0 modules allow the ON/OFF control of the condenser fans.
The control relay has a switching power 10A at 250 Vac in AC1 (1/3 HP inductive).

ND



Fig. 11.a

12 PWM to 0 to 10 Vdc (or 4 to 20 mA) conversion board for fans (code CONV0/10A0)

The CONV0/10A0 modules convert the PWM signal sent from terminal Y on the µRack to a standard 0 to 10 Vdc (or 4 to 20 mA) signal. The FCS series three-phase controllers can be connected to the µRack without requiring this module.

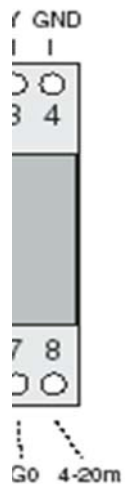

Fig. 12.a

13 Programming key (code PSOPZKEYA0)

The programming keys PSOPZKEY00 and PSOPZKEYA0 for CAREL controllers are used to copy the complete set of parameters to the µRack. The keys must be connected to the connector (4 pin AMP) on the controllers, and can operate when the instruments are either on or off, according to the instructions for the specific controller.

There are two main functions, which are selected using the two dipswitches (located under the battery cover). These are:

- Load the parameters from a controller to the key (UPLOAD);
- Copy from the key to one or more controllers (DOWNLOAD).

Warning: The parameters can only be copied only between instruments with the same product code. The upload operation, on the other hand, is always possible. To assist the identification of the key to be used, CAREL has applied a label that can be used to describe the programming made or the unit that the data refers to.

IMPORTANT NOTE: The key can only be used on µRack controllers that have the same firmware version.

Refer to the programming key instruction sheet for further details.



Fig. 13.a

14 Supervisor management

The controller can be connected to a local or remote supervisor/telemaintenance system for managing the unit. The variables sent and received by the supervisor are shown in the tables below, with reference to the following key:

R	Read	Send from the µRack to the supervisor. Not modifiable
R/W	Read- Write	Received and sent from the µRack to the supervisor. Can be modified by the supervisor.

Analogue variables

Flow	Index	Description	Display code
R	1	Probe B4	LP1
R	2	Probe B1	HP/LP2
R	3	Probe B2 (ambient air)	B2
R	4	Probe B3 (outside air)	B3
R/W	5	Suction set point circuit 1	r01
R/W	6	Differential circuit 1	r02
R/W	7	Suction set point circuit 2	r03
R/W	8	Differential circuit 2	r04
R/W	9	Min suction set point 1	r12
R/W	10	Max suction set point 1	r13
R/W	11	Min suction set point 2	r14
R/W	12	Max suction set point 2	r15
R/W	13	Fan set point	r16 (bar)
R/W	14	Fan set point	r16 (°C)
R/W	15	Fan differential	r17 (bar)
R/W	16	Fan differential	r17 (°C)

Flow	Index	Description	Display code
R/W	17	Min fan set point	r25 (bar)
R/W	18	Min fan set point	r25 (°C)
R/W	19	Max fan set point	r26 (bar)
R/W	20	Max fan set point	r26 (°C)
R/W	21	Fan inverter set point	r18 (bar)
R/W	22	Fan inverter set point	r18 (°C)
R/W	23	Fan inverter differential	r19 (bar)
R/W	24	Fan inverter differential	r19 (°C)
R/W	25	HP suction 1 alarm threshold	A01
R/W	26	LP suction 1 alarm threshold	A03
R/W	27	HP suction 2 alarm threshold	A05
R/W	28	LP suction 2 alarm threshold	A07
R/W	29	HP discharge alarm threshold	A09 (bar)
R/W	30	HP discharge alarm threshold	A09 (°C)
R/W	31	LP discharge alarm threshold	A10 (bar)
R/W	32	LP discharge alarm threshold	A10 (°C)
R/W	33	Probe B4 calibration	/23
R/W	34	Probe B1 calibration	/24
R/W	35	Probe B2 calibration	/25
R/W	36	Probe B3 calibration	/26
R/W	37	Min value suction probe	/17
R/W	38	Min value discharge probe	/18
R/W	39	Max value suction probe	/19
R/W	40	Max value discharge probe	/20
R/W	41	Set point prevent high pressure function	/33
R/W	42	Set point offset to change set from DI	r34
R/W	43	Differential pressure for dead band by time	r11
R/W	44	Condensing temperature delta for floating control	r33
R/W	45	High temp threshold probe B2	A16
R/W	46	High temp threshold probe B3	A17

Tab. 14.a

Digital variables

Flow	Index	Description	Parameter
R/W	1	Unit on	
R	2	Status of compressor 1	
R	3	Status of compressor 2	
R	4	Status of compressor 3	
R	5	Status of compressor 4	
R	6	Status of fan 1	
R	7	Status of fan 2	
R	8	Status of fan 3	
R	9	Status of fan 4	
R	10	Status of digital input 1	
R	11	Status of digital input 2	
R	12	Status of digital input 3	
R	13	Status of digital input 4	
R	14	Status of digital input 5	
R/W	15	Reset alarms	A19
R/W	16	Digital input logic	/14
R/W	17	Alarm relay logic	/28
R/W	18	Enable fan inverter	/10
R/W	19	ON/OFF from supervisor	/38
R/W	20	Enable "prevent" control on condenser	/32
R/W	21	Enable management of different compressors	/02
R/W	22	Type of compressor reset	/29
R/W	23	Type of fan reset	/30
R/W	24	Type of reset for general high press. switch	/31
R/W	25	Reset compressor 1 hours	C09
R/W	26	Reset compressor 2 hours	C11
R/W	27	Reset compressor 3 hours	C13
R/W	28	Reset compressor 4 hours	C15
R/W	29	Enable floating condenser control	r32
R/W	30	Enable unit Off due to probe fault	A22
R/W	31	Enable fans with compressor ON	/13

Tab. 14.b

Alarms sent to the supervisor

Flow	Index	Description	Alarm code
R	1	Alarm: compressor 1	A01
R	2	Alarm: compressor 2	A02
R	3	Alarm: compressor 3	A03
R	4	Alarm: compressor 4	A04
R	5	Alarm: fan 1	A22
R	6	Alarm: fan 2	A23
R	7	Alarm: fan 3	A24
R	8	Alarm: fan 4	A25
R	9	Alarm: liquid level	A09
R	10	Alarm: general low suction pressure 1 (from multifunction DI)	A10
R	11	Alarm: general low suction pressure 2 (from multifunction DI)	A11
R	12	Alarm: low discharge pressure	A13
R	13	Alarm: high discharge pressure	A14
R	14	Alarm: low suction pressure 1"	A15
R	15	Alarm: high suction pressure 1	A16
R	16	Alarm: low suction pressure 2	A17
R	17	Alarm: high suction pressure 2 "	A18
R	18	Probe B1 faulty or disconnected	A20
R	19	Probe B2 faulty or disconnected	AB2
R	20	Probe B3 faulty or disconnected	AB3
R	21	Probe B4 faulty or disconnected	A19
R	22	Compressor 1 maintenance	A05
R	23	Compressor 2 maintenance	A06
R	24	Compressor 3 maintenance	A07
R	25	Compressor 4 maintenance	A08
R	26	General discharge pressure switch (from multifunction DI)	A12
R	27	General fan thermal overload	A26
R	28	Prevent high discharge pressure	A27
R	29	Compressors off due to prevent	A28
R	30	Excessive prevent frequency	A29
R	31	High outside temperature	HE
R	32	High room temperature	HtA

Tab. 14.c

Integer variables

Flow	Index	Description	Parameter
R/W	1	Type of unit "/00"	/00
R/W	2	Unit model "/01"	/01
R	3	Number of compressors	
R/W	4	Number of fans "/09"	/09
R	5	Unit status 0 = Unit ON 1 = OFF from alarm 2 = OFF from supervisor 3 = OFF from remote input 4 = OFF from parameter 5 = Manual operation 6 = Install default 7 = PREVENT IN PROGRESS	
R/W	6	Minimum call time for compressor start (dead band)	r07
R/W	7	Minimum call time for compressor stop (dead band)	r09
R/W	8	Minimum compressor ON time	C01
R/W	9	Minimum compressor OFF time	C02
R/W	10	Minimum time between starts of different compressors	C03
R/W	11	Minimum time between starts of the same compressor	C05
R/W	12	Reserved	
R/W	13	Reserved	
R/W	14	Liquid level alarm delay	A18
R/W	15	Reserved	
R/W	16	Number of compressors on in circuit 1 with probe damaged	/07
R/W	17	Number of compressors on in circuit 2 with probe damaged	/08
R/W	18	Number of fans on with probe damaged	/12
R	19	Firmware release	
R/W	20	Type of refrigerant	/35
R/W	21	Capacity of compressor 1	/03
R/W	22	Capacity of compressor 2	/04
R/W	23	Capacity of compressor 3	/05
R/W	24	Capacity of compressor 4	/06
R	25	Inverter readout % "	/11
R/W	26	Multifunction DI configuration	/15
R/W	27	B1 type probe	/16

Flow	Index	Description	Parameter
R/W	28	B2 type probe	/21
R/W	29	B3 type probe	/22
R/W	30	Delay restart after black out	/37
R/W	31	Min time between two stop calls for different compressors	C04
R/W	32	Time between compressor stop call with Prevent function	C06
R/W	33	Operating hour threshold for maintenance	C07
R	34	Compressor 1 hours	C08
R	35	Compressor 2 hours	C10
R	36	Compressor 3 hours "	C12
R	37	Compressor 4 hours	C14
R/W	38	Type of compressor rotation	r05
R/W	39	Type of compressor control	r06
R/W	40	Maximum call for compressor starts in dead band by time	r08
R/W	41	Maximum call for compressor stops in dead band by time	r10
R/W	42	Type of fan rotation	r20
R/W	43	Type of fan control	r21
R/W	44	Integral time for P+I fan control	r22
R/W	45	Time between 2 fans starts in dead band	r23
R/W	46	Time between 2 fans stops in dead band	r24
R/W	47	Inverter speed up time	r27
R/W	48	Inverter ramp up time	r28
R/W	49	Minimum inverter output %	r29
R/W	50	Maximum inverter output %	r30
R/W	51	Triac impulse duration	r31
R/W	52	High suction pressure 1 alarm delay	A02
R/W	53	Low suction pressure 1 alarm delay	A04
R/W	54	High suction pressure 2 alarm delay	A06
R/W	55	Low suction pressure 2 alarm delay	A08
R/W	56	Low discharge pressure alarm delay	A11
R/W	57	Compressor thermal overload alarm delay	A12
R/W	58	Prevent time in which no compressor starts are enabled	A13
R/W	59	Prevent time in which the activation signals the alarm	A14
R/W	60	Time to reset prevent alarm	A15
R/W	61	Alarm signal delay	A20
R/W	62	Time to change low pressure alarm from automatic to manual	A21
R/W	63	B4 type probe	/43
R	65	Capacity percentage of first capacity-controlled compressor with configuration /01= 9,10,11,12,13 e 14	
R	66	Capacity percentage of second capacity-controlled compressor without configuration /01= 9,10,11,12,13 e 14	

Tab. 14.d

15 Default configurations

Signal	Type of analogue inputs	Description
B1	Analogue input 1	Discharge pressure probe
B2	Analogue input 2	Ambient air temperature probe
B3	Analogue input 3	Outside air temperature probe
B4	Analogue input 4	Suction pressure probe

Tab. 15.a

Signal	Type of analogue outputs	Description
Y	PWM analogue output	Fan inverter

Tab. 15.b

Signal	Type of digital inputs	Description
ID1	N.C. digital input no. 1	Comp. 1 thermal overload
ID2	N.C. digital input no. 2	Comp. 2 thermal overload
ID3	N.C. digital input no. 3	Fan 1 thermal overload
ID4	N.C. digital input no. 4	Fan 2 thermal overload
ID5	N.C. digital input no. 5	General high pressure switch

Tab. 15.c

Signal	Type of digital outputs	Description
NO1	Normally open contact, relay no. 1	Compressor 1
NO2	Normally open contact, relay no. 2	Compressor 2
NO3	Normally open contact, relay no. 3	Fan 1
NO4	Normally open contact, relay no. 4	Fan 2
NO5	Normally open contact, relay no. 5	Generic alarm

Tab. 15.d

16 Glossary

Analogue value: integer value with minus sign and decimal point.

Buffer (memory): memory on the board used to save the default values selected by CAREL for all the parameters. Permanent memory, saves the values even when power is disconnected.

Buzzer: buzzer fitted on the external terminals; this sounds in the event of alarms or the limits set for the parameters are exceeded. The Built-in terminals do not have a buzzer.

Digital value: value with only two states.

Differential: defines a pressure (or temperature) difference from the corresponding set point.

Discharge: pressure or temperature measured at the compressor outlet. This is an analogue value.

HP : High pressure

Integer value: integer value without decimal point.

LP : Low pressure

Proportional band: this defines a temperature (or pressure) zone of a few degrees starting from the set point, inside which the system manages the control devices.

Range: range of values available for a parameter.

Step: defines an area of the proportional band (pressure or temperature) inside which a device is on, and at the same time also defines the device on/off values.

Set point: defines a pressure (or temperature) value to be satisfied; the system activates or deactivates the devices so that the value measured reaches the set point.

Suction: pressure or temperature measured at the compressor intake. This is an analogue value.

Upload: the operation used to copy the application software from the computer or programming key to the µRack.

17 Technical specification

“Group A” is defined in the following specifications as the grouping of the following outputs: compressor 1, compressor 2, fan 1, fan 2, alarm.

Power supply	24 Vac, range -15% ~ +10%; 50/60 Hz Maximum current output: 3 W Fuse to be fitted in series with the power supply of the µRack: 315 mA
12-pin connector	Max current 2 A for each relay output, extendable to 3 A for one output
Relays	Max current at 250 Vac: EN60730: Resistive: 3 A, Inductive: 2 A cos (j)= 0.4 60000 cycles UL: Resistive 3 A, 1 FLA , 6 LRA cos (j)= 0.4 30000 cycles Minimum interval between switching cycles (each relay): 12 s (the manufacturer of the unit that the device is built into must ensure the correct configuration to respond to this specification) Type of micro-switching of the relay: 1 C Insulation between relays in group A: functional Insulation between relays in group A and the very low voltage parts: reinforced Insulation between relays in group A and the signal relay: primary Insulation between the signal relay and the very low voltage parts: reinforced Insulation between relays and the front panel: reinforced
Digital inputs ID1 to ID5, IDB4	Electrical standard: voltage-free contact Closing current to ground: 5 mA Maximum closing resistance: 50 W
Analogue inputs	B1, B2, B3, B4: CAREL NTC temperature probes (10 kW at 25 °C) The response time depends on the component used, typical value 90 sec. B4: NTC temp. probes (10 kW at 25 °C) or CAREL 0 to 5 V or free contact ratiometric pressure probes
Fan output	Control signal for CAREL MCHRTF****, CONVONOFF*, CONV0/10A* and FCS modules. Modulation of impulse position (set amplitude) or modulation of the duty-cycle. Refer to the user manual for the configuration of the parameters Loadless voltage: 5 V ± 10% Short-circuit current: 30 mA Minimum output load: 1 kW
Front panel index of protection	IP55
Storage conditions	-10T70°C - humidity <80% r.H., non-condensing
Operating conditions	-10T50°C - humidity <90% r.H., non-condensing
Degree of pollution	Normal
Cat. of resist. to heat and fire	D (UL94 V0)
PTI of the insulating materials	≥250 V
Class and structure of the software	A
Period of electrical stress across the insulating parts	long

Note: All the relays must have the commons (C1/2, C3/4) connected together, as shown in Fig. 1 e 2

Functional specifications

Resolution of analogue inputs	Temperature probes: range -40T80°C, 0.1 °C
Temperature measurement error	Range -20T20 °C, ±0.5 °C (excluding probe) Range -40T80 °C, ±1.5 °C (excluding probe)
Pressure measurement error	The voltage % error in the input range of 0.5 to 4.5 Vdc is ± 2% (excluding probe).

18 Product codes list

MRK0000000: μRack panel mounting 32x74, 24 Vac, with connectors kit

MRK00000D0: μRack DIN rail mounting, 24 Vac, with connectors kit

MRK0000AD0: μRack DIN rail mounting, RS485 preinstalled serial board, 24 Vac, with connectors kit

The connectors kit contains:

Polarized mini-fit connector 2x6 pin female

Polarized mini-fit connector 2x7 pin female

removable terminal right angle female 3 pin, pitch= 3.81 mm, high= 11.1 mm

removable terminal right angle female 3 pin, pitch = 5.08 mm, high= 11.1 mm (DIN version only)

Accessories

MCH2CON001: connectors kit for μChiller2/μRack panel mounting version

MCH2CON011: connectors kit for μChiller2/μRack DIN rail mounting version

Warning: the connectors kit MCH2CON* contains a 2 pins connector for the tLAN which is not used for μRack

MCHSMLCONM: mini-fit 2x6 and 2x7 pin connectors kit

MCHSMLCAB0: 24 cables kit 1 mm², L= 1 m, preset for mini-fit connection

MCHSMLCAB2: 24 cables kit 1 mm², L= 2 m, preset for mini-fit connection

MCHSMLCAB3: 24 cables kit 1 mm², L= 3 m, preset for mini-fit connection

MCH2004850: RS485 serial board for per μRack panel mounting version

FCSER00000: RS485 serial board for per μRack DIN rail mounting version

PSOPZKEY00: programming key with 12 Vdc batteries included

PSOPZKEYA0: programming key with 230 Vac external power supply

KIT

code	uRack	RS485	Ratiometric pressure probe				Cables for pressure probe	Connectors kit	2 m cables kit MCHSMLCAB2
			-1...4,2 bar	-1...9,3 bar	-1...12,8 bar	0...34,5 bar			
MRK00010DK	DIN	No	1			1	2	DIN	No
MRK000200K	panel	No	1			1	2	panel	No
MRK00030DK	DIN	No	1			1	2	DIN	Yes
MRK000400K	panel	No	1			1	2	panel	Yes
MRK00050DK	DIN	No		1		1	2	DIN	Yes
MRK000600K	panel	No		1		1	2	panel	Yes
MRK00090DK	DIN	No			1	1	2	DIN	Yes
MRK000800K	panel	No			1	1	2	panel	Yes

19 Appendix: Compressor rack controller, examples of application diagrams

4 compressors unit with fan speed regulator

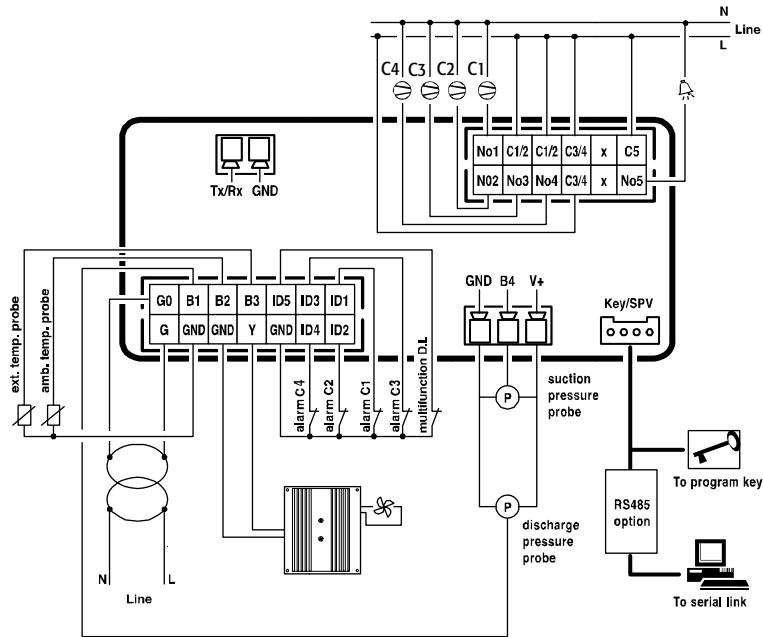

Fig. 17.a

2 compressors unit + 2 condenser fans

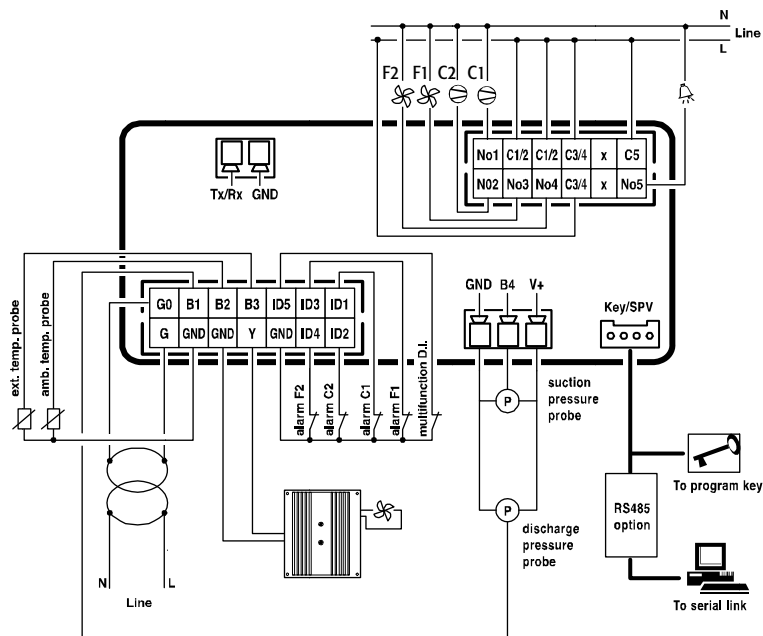

Fig. 17.b

3 compressors unit with 2 fan steps and speed regulator (no alarm relay output)

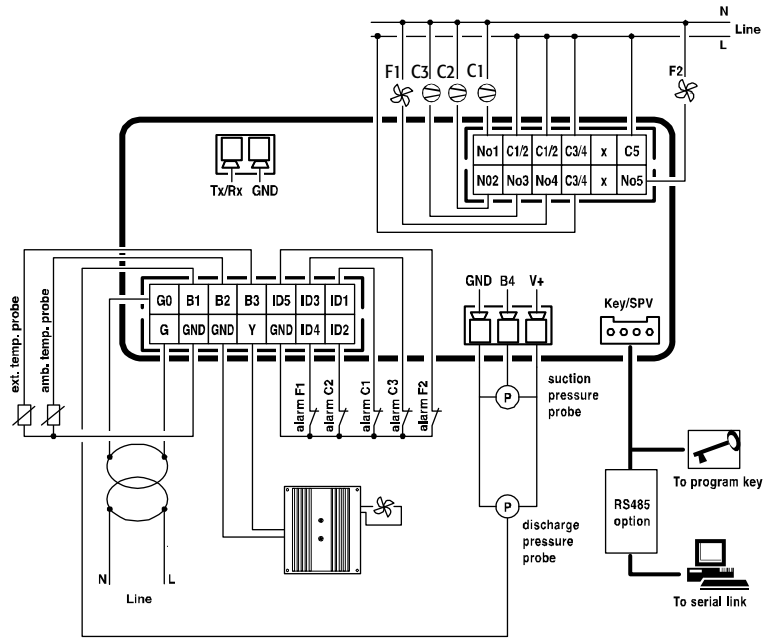

Fig. 17.c

2 compressors unit + 3 condenser fans

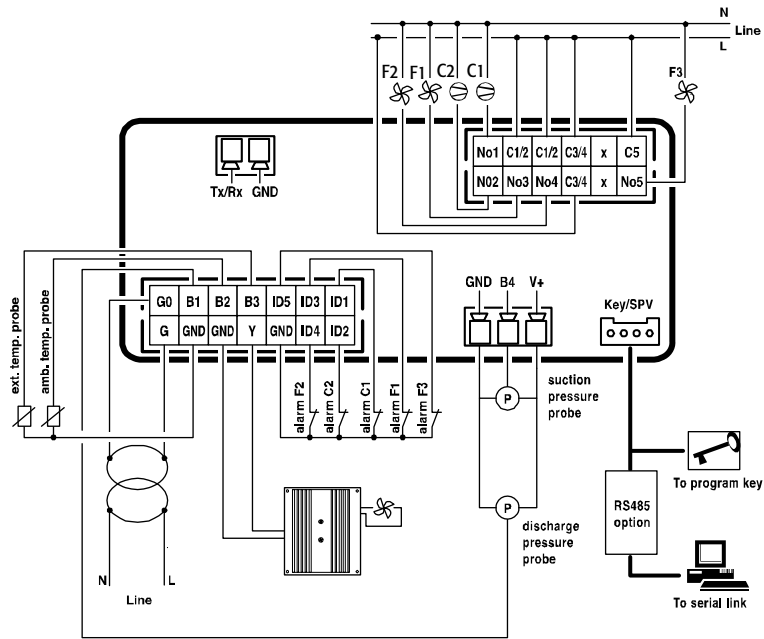

Fig. 17.d

20 Appendix: Changes introduced in Fw release 2.0 for MRK0000XX0

The latest FW release has changed from 1.7 to 2.0

Modifications have been made to the following strings:

- AS2 has been replaced by AB2;
- AS3 has been replaced by AB3;
- S3 has been replaced by B2;
- S4 has been replaced by B3.

In the case of two refrigerant circuits, a fixed delay of 4 seconds has been introduced between the start of the first compressor in the first refrigerant circuit and the start of the first compressor in the second refrigerant circuit.

The following "/" parameters have been modified:

- /15:** The default value has been changed from 3 to 0
/17: The max. value is now /19
/18: The max. value is now /20
/19: The default value has been changed from 4.1 bars to 9.3 bars
 The max. value has been changed from 40 bars to 45 bars
/20: The max. value has been changed from 40 bars to 45 bars
/29: The default value has been changed from 1 to 0
/30: The default value has been changed from 1 to 0
/33: The max. value is now 45 bars
/34: The parameter has been made not visible
/43: New parameter for setting probe B4.
 The SONDA_B4 parameter now is visible and can be set on the display and from the supervisor.
 Setting to 0 means the probe is not used.
 Settings 1 and 2 mean it used as a pressure probe.

The following "C" parameters have been modified:

- C03:** The default value has been changed from 20 sec to 30 sec
C04: The default value has been changed from 20 sec to 10 sec
C07: **The compressor maintenance hour threshold has been increased:**
 The max. value has been changed from 999 (hours x 10) to 320 (hours x 100)
 The default value has been changed from 200 (hours x 10) to 0 (hours x 100)
C08: The max. value has been changed from 999 (hours x 10) to 320 (hours x 100)
C10: The max. value has been changed from 999 (hours x 10) to 320 (hours x 100)
C12: The max. value has been changed from 999 (hours x 10) to 320 (hours x 100)
C14: The max. value has been changed from 999 (hours x 10) to 320 (hours x 100)

The following "r" parameters have been modified:

- r01:** The min. value is now r12
 The max. value is now r13
r03: The min. value is now r14
 The max. value is now r15
r11: The min. value has been changed from 0 to /17 (min value of suction probe B4) (min. value of setpoint1 = -1.0 bars)
r12: The min. value has been changed from 0 to /17 (min value of suction probe B4) (min. value of setpoint1 = -1.0 bars)
r13: The default value has been changed from 2.5 bars to 9.3 bars
 The max. value has been changed from 40 bars to /19
r14: The min. value has been changed from 0 to /18 (min value of probe B1) (min. value of setpoint2 = -1.0 bars)
r15: The max. value has been changed from 40 bars to /20 (max. value of suction probe B1)
 The default value has been changed from 2.5 bars to 10 bars
r17: The default value has been changed from 0.5 bars (3°C) to 3 bars (18°C)
r19: The default value has been changed from 0.5 bars (3°C) to 3 bars (18°C)
r23: The times for the fans in the dead zone also apply to the proportional band (ZN only indication removed)
r24: The times for the fans in the dead zone also apply to the proportional band (ZN only indication removed)
r26: The max. value has been changed from 40 bars to /20 (max. value of suction probe B1)

The following "A" parameters have been modified:

- A01:** The default value has been changed from 4 bars to 9.3 bars
 The max. value has been changed from 40 bars to /19 (max. value of suction probe B4)
A03: The default value has been changed from 0.5 bars to 0 bars
A05: The default value has been changed from 4 bars to 9.3 bars
 The max. value has been changed from 40 bars to /20 (max. value of suction probe B1)
A07: The default value has been changed from 0.5 bars to 0 bars
A09: The max. value has been changed from 40 bars to /20
A10: The default value has been changed from 10 bars (20°C) to 0 bars (-50°C)
 The min. value has been changed from 0 bars (0°C) to /18 (-50°C)
A18 has been changed from seconds to minutes:
 The default value has been changed from 90 sec to 60 min
 The max. value has been changed from 999 sec to 500 min

21 Appendix: Changes introduced in Fw release 2.1

The latest FW release has changed from 2.0 to 2.1

Modifications have been made to the following strings:

- arranging of Speed-Up Inverter mode and calculation of minimum and maximum speed inverter;
- arranging of Floating condenser control;
- change of alarm delay to start-up; now, more than the value of the DELAY_START parameter, is included the delay imposed by their relative parameter

22 Appendix: Changes introduced in Fw release 2.2

The FW release has changed from 2.1 to 2.2

The display of variables relating to fan set point has been corrected when the floating condensing function is enabled and a condensing pressure probe is used.

The "Suction_Probe1_Alarm", "Suction_Probe1_Alarm and "Discharge_Probe_Alarm" alarms have changed from manual to automatic reset.

23 Appendix: Changes introduced in Fw release 2.3

The FW release has changed from 2.2 a 2.3

New types of units have been added to increase the product portfolio, with the introduction of single-circuit and two-circuit units with capacity control; the time between activation of capacity-control steps is fixed (5 seconds).

The following "/" parameters have been modified:

/01: Range extended from 0-8 to 0-14

Two integer variables have been added (visible to supervisor only):

int 65 "Operating percentage of first capacity controlled compressor in configurations /01= 9,10,11,12,13 and 14"

int 66 "Operating percentage of second capacity controlled compressor in configurations /01= 9,10,11,12,13 and 14"

CAREL reserves the right to make modifications or changes to its products without prior notice.

CAREL

CAREL INDUSTRIES HQs

Via dell'Industria, 11 - 35020 Brugine - Padova (Italy)
Tel. (+39) 049.9716611 Fax (+39) 049.9716600
<http://www.carel.com> - e-mail: carel@carel.com

